

Listino prezzi
Price-list
Liste des prix
Preisliste
Lista de precios

LOOK

MAY 2015

Loran
everyday passion

SPECIFICHE

Specifications / Spécifications / Spezifikationen / Especificaciones _____ 2

COLORI

Colors / Couleurs / Farben / Colores _____ 4

DISEGNI TECNICI

Technical drawings / Dessins techniques / Technische Zeichnungen / Planos técnicos _____ 6

MODULI

Units / Modules / Schränke / Módulos _____ 10

BASAMENTI - SUPPORTI

Base units - Supports / Bases - Supports / Sockel - Support / Bases - Soporte _____ 15

BACINELLE

Trays / Intérieurs de tiroir / Einsätze / Bandejas _____ 19

PIANI

Tops / Plans / Arbeitsplatten / Encimeras _____ 21

ALZATINE

Splashbacks / Dossierets / Aufkantungen / Alzadas _____ 23

LAVELLI

Sinks / Eviers / Waschbecken / Lavabos _____ 26

RUBINETTI

Mixers / Robinets / Wasserhähne / Grifos _____ 27

CASSETTI

Drawers / Tiroirs / Schubladen / Cajones _____ 28

ACCESSORI

Accessories / Accessoires / Zubehör / Accesorios _____ 29

RICAMBI

Spare parts / Pièces détachées / Ersatzteile / Recambios _____ 31

COMPOSIZIONI

Compositions / Compositions / Zusammenstellungen / Composiciones _____ 33

CONDIZIONI GENERALI DI VENDITA

General terms of sale / Conditions générales de vente /
Allgemeine Verkaufsbedingungen / Condiciones generales de venta _____ 38

MODULI

Aggiungere ad ogni elemento il prezzo del supporto a pavimento o a muro, o del basamento e relativi fianchi laterali dove necessari, del piano, dell'alzatina, del lavello e del rubinetto.

(Il sottopiano è già incluso nei moduli).

I moduli su misura possono essere realizzati solo con anta: applicare il prezzo dell'articolo di misura superiore con un supplemento del 25%.

ATTENZIONE

Indicare sempre le misure delle apparecchiature che devono essere inserite nei moduli.

Le composizioni si intendono sempre a partire da sinistra verso destra. Specificare i colori di fianchi, frontali e sottopiano.

PER COLORI STANDARD SI INTENDE:

- Bianco Loran per i frontali, i fianchi di finitura e i basamenti
- Colori RAL per il sottopiano, ad eccezione dei Colori RAL metallizzati/perlati e brillanti

Specificare dimensioni e tipo di piano, alzatina, lavello e rubinetto.

Per composizioni con elementi ad angolo verificare la perpendicolarità delle pareti (90°): considerando la distanza di 80 cm. su una parete e 60 cm. sull'altra, la diagonale deve corrispondere a 100 cm.

Dimensioni: L = Larghezza P = Profondità H = Altezza

MANIGLIE ALLUMINIO

N.B.: solo in alluminio, **NO** verniciate.

SUPPORTI A PAVIMENTO

N.B.: solo in alluminio, **NO** verniciati.

CORIAN®, STRATIFICATO E LAMINATO FENIX®: solo di colore bianco.

MAGGIORAZIONI DI PREZZO PER COLORAZIONI SPECIALI

- RAL standard:

| | |
|---|-----------|
| Supplemento coppia fianchi di finitura | + 90,00 € |
| Supplemento serie frontali/anta (ogni mobile) | + 90,00 € |
| Basamento (ogni mobile) | + 30,00 € |
- RAL metallizzati/perlati e brillanti e in altri colori diversi dalla cartella RAL:

| | |
|---|------------|
| Supplemento coppia fianchi di finitura | + 180,00 € |
| Supplemento serie frontali/anta (ogni mobile) | + 180,00 € |
| Basamento (ogni mobile) | + 60,00 € |
| Sottopiano (ogni mobile) | + 60,00 € |

SPESE IMBALLO: ogni collo € 15,00 prezzo netto.

UNITS

Add the floor support, wall support or base and sides price, the top, splashback, sink and mixer prices to each unit.

(Undercounter included).

Made-to-measure units: apply the price of the article with the next greater size and add a 25% extra charge.

ATTENTION

Always provide the dimensions of the appliances that will be built into the units.

The compositions are always understood as starting from the left to the right.

Specify the colors of the lateral sides, fronts and undercounter.

STANDARD COLORS:

- Bianco Loran / White Loran for sides and fronts, sides and bases.
- RAL colors for the undercounter (NOT metallized/pearl and luminous RAL colors)

Specify the dimensions and type of top, splashback, sink and mixer.

Straight compositions with technical raceway and sink: use tops with minimum depth 520 mm.

For compositions with corner elements check that the walls are perfectly perpendicular (90°): considering the distance of 80 cm on the right and 60 cm left hand sides of the corner, the diagonal line must be 100 cm.

Dimensions: L = Width P = Depth H = Height

ALUMINIUM HANDLE

Attention: only aluminium, NOT painted.

FLOOR SUPPORT

Attention: only aluminium, NOT painted.

CORIAN®, STRATIFIED and LAMINATE FENIX®: only in white color.

UPCHARGES FOR SPECIAL COLORS

- Standard RAL:

| | |
|-------------------------------------|-----------|
| Sides (2x): upcharge | + 90,00 € |
| Fronts/door: upcharge for each unit | + 90,00 € |
| Base: upcharge for each unit | + 30,00 € |
- Metallized/pearl and luminous RAL colors and other different colors from the RAL colors:

| | |
|--------------------------------------|------------|
| Sides (2x): upcharge | + 180,00 € |
| Fronts/door: upcharge for each unit | + 180,00 € |
| Base: upcharge for each unit | + 60,00 € |
| Undercounter: upcharge for each unit | + 60,00 € |

PACKING COSTS:

each package € 15.00 net price

MODULES

À chaque module il faut ajouter le prix de: support au sol, support au mur, base et cotés, plan, dossier, évier et robinet.
(Sous plan inclus).

Les modules sur mesure peuvent être réalisés uniquement avec une porte: appliquer le prix de l'article de mesure supérieure et ajouter un supplément de 25%.

ATTENTION

Indiquer obligatoirement les mesures exactes des appareils destinés à être introduits dans les meubles.
Les compositions s'entendent toujours en partant de gauche vers la droite.
Spécifier les couleurs des panneaux latéraux, façades et partie sous plan.

COULEURS STANDARD:

- Blanc Loran pour les côtés, les façades et les bases.
- Couleurs RAL pour le sous plan, sauf que les couleurs RAL métallisés/pearl et lumineux

Spécifier les dimensions et le type du plan, du dossier, du lavabo et du robinet.
Pour les compositions avec des éléments d'angle, contrôler soigneusement la perpendicularité des murs (90°): si on prend la distance exacte de 80 cm à droite et 60 cm à gauche de l'angle, la diagonale devra mesurer 100 cm.

Dimensions : L = Largeur P = Profondeur H = Hauteur

POIGNÉE EN ALUMINIUM

Attention: en aluminium, PAS peint.

SUPPORTS AU SOL

Attention: en aluminium, PAS peint.

CORIAN®, STRATIFIE' et LAMINE' FENIX®: en couleur blanc seulement.

SUPPLÉMENTS DE PRIX POUR COULEURS SPÉCIALES

- **RAL standard:**
Côtés (2x) : supplément de prix + 90,00 €
Façades/porte: supplément de prix pour chaque module + 90,00 €
Base: supplément de prix pour chaque module + 30,00 €
- **Couleurs RAL métallisés/pearl et lumineux et d'autres couleurs différentes des couleurs RAL:**
Côtés (2x) : supplément de prix + 180,00 €
Façades/porte: supplément de prix pour chaque module + 180,00 €
Base: supplément de prix pour chaque module + 60,00 €
Sous plan: supplément de prix pour chaque module + 60,00 €

FRAIS D'EMBALLAGE:

prix net de chaque colis € 15,00

SCHRÄNKE

Bei jedem Element muss der Preis der Bodengestell, Wandbefestigung, Sockel und Seiten der Arbeitsplatte, der Aufkantung, der Spüle und der Wasserhahn separat berechnet werden.
(Unterbaus enthalten).

Maßgefertigte Schränke können nur mit Tür hergestellt werden: auf den Preis des nächst größeren Artikels einen Mehrpreis von 25% berechnen.

VORSICHT

Immer die Maße der Geräte angeben, die in die Schränke eingebaut werden.
Die Anbaulösungen sind immer von links nach rechts angegeben.
Die Farben der Seiten, der Fronten und des Unterbaus angeben.

STANDARD FARBEN:

- Loran Weiss für Seiten, Fronten und Sockel.
- RAL Farben für Unterbaus (keine Metallic/Perl und leuchtende RAL-Farben)

Abmessungen und Art der Arbeitsplatte, Aufkantung, Spüle und Wasserhahn angeben.
Bei Anbaulösungen mit Eckelementen auf lotrechte (90°) Wände achten: bei einem Abstand von 80 cm rechts und 60 cm links von der Ecke muss die Diagonale 100 cm betragen.

Abmessungen: L = Breite P = Tief H = Höhe

ALUMINIUMGRIFF

Bitte beachten: Aluminium, NICHT lackiert.

BODENGESTELL

Bitte beachten: Aluminium, NICHT lackiert.

CORIAN®, SCHICHTSTOFF und LAMINAT FENIX®: nur weiß.

AUFPREIS FÜR SONDERFARBEN

- **Standard RAL:**
Seiten (2x) : Aufpreis + 90,00 €
Fronten/Tür: Aufpreis für jede Schrank + 90,00 €
Sockel: Aufpreis für jede Schrank + 30,00 €
- **Metallic/Perl und leuchtende RAL-Farben und anderen verschiedenen Farben der RAL-Farben:**
Seiten (2x) : Aufpreis + 180,00 €
Fronten/Tür: Aufpreis für jede Schrank + 180,00 €
Sockel: Aufpreis für jede Schrank + 60,00 €
Unterbaus: Aufpreis für jede Schrank + 60,00 €

VERPACKUNGSKOSTEN:

jedes Paket € 15,00 Nettopreis

MÓDULOS

Añadir a cada elemento el precio del soporte de pie, del soporte en pared, de la base y de los paneles laterales, de la encimera, de la alzada, del lavabo y del grifo.
(Pieza debajo de la encimera incluida).
Los muebles a la medida pueden realizarse sólo con la puerta: aplicar el precio del artículo de medida superior con un recargo del 25%.

ATENCIÓN

Indicar siempre las medidas de los equipos que deben introducirse en los módulos.
Las composiciones se consideran siempre a partir de la izquierda hacia la derecha.
Especificar los colores de los paneles laterales, de los frentes y de la pieza debajo de la encimera.

COLORES ESTANDAR:

- Blanco Loran para los paneles laterales, los frentes y las bases.
- Colores RAL por la pieza debajo de la encimera, con la excepción de los colores RAL metalizados/perla y brillantes

Especificar las dimensiones y el tipo de encimera, de alzada, de lavabo y de grifo.
Para composiciones con elementos en ángulo controlar la perpendicularidad de las paredes (90°): considerando la distancia de 80 cm a la dcha. y 60 cm a la izq.. del ángulo, la diagonal debe corresponder a 100 cm.

Dimensiones: L = Ancho P = Profundidad H = Alto

TIRADOR DE ALUMINIO

Atención: en aluminio, no pinta.

SOPORTE DE PIE

Atención: en aluminio, no pinta.

CORIAN®, ESTRATIFICADO y LAMINADO FENIX®: de color blanco.

CARGOS ADICIONAL PARA COLORACIONES ESPECIALES

- **RAL estándar:**
Laterales (2x): cargo adicional +€ 90,00
Frentes/puerta: cargo adicional por cada módulo +€ 90,00
Base: cargo adicional por cada módulo +€ 30,00
- **RAL metalizados/perla y brillantes y otros colores diferentes de colores RAL:**
Laterales (2x): cargo adicional +€ 180,00
Frentes/puerta: cargo adicional por cada módulo +€ 180,00
Base: cargo adicional por cada módulo +€ 60,00
Pieza debajo de la encimera por cada módulo +€ 60,00

EMBALAJE:

cada paquete € 15,00 precio neto

COLORI PER FRONTALI, FIANCHI E BASAMENTI A RICHIESTA / Colours for fronts, sides and bases on request / Couleurs pour façades, panneaux latéraux et bases sur demande / Farben für Fronten, Seiten und Sockel auf Anfrage / Colores de los frentes, los paneles laterales y las bases de pedido

Finiture verniciate / Painted finishes / Finitions peintes / Lackierten Ausführungen / Acabados pintados

| | | | | | | | | |
|-----------------|-----------------|-----------------|-----------------|-----------------|-----------------|-----------------|-----------------|-----------------|
| | | | | | | | | |
| RAL 9005 | RAL 7016 | RAL 5012 | RAL 5014 | RAL 5022 | RAL 5024 | RAL 6000 | RAL 6019 | RAL 6027 |
| | | | | | | | | |
| RAL 9002 | RAL 9001 | RAL 8019 | RAL 7045 | RAL 7038 | RAL 7022 | RAL 7022 | RAL 7038 | RAL 7045 |
| | | | | | | | | |
| RAL 5010 | RAL 5002 | RAL 5000 | RAL 4006 | RAL 4002 | RAL 3016 | RAL 3004 | RAL 1018 | RAL 1015 |
| | | | | | | | | |
| RAL 2012 | RAL 2001 | RAL 1023 | RAL 1018 | RAL 1015 | RAL 1015 | RAL 1015 | RAL 1015 | RAL 1015 |
| | | | | | | | | |
| RAL 3000 | RAL 3000 | RAL 3000 | RAL 3000 | RAL 3000 | RAL 3000 | RAL 3000 | RAL 3000 | RAL 3000 |
| | | | | | | | | |
| BIANCO | RAL 1015 | RAL 1018 | RAL 1023 | RAL 2001 | RAL 2012 | RAL 3000 | RAL 3000 | RAL 3000 |

Colorazioni speciali con maggiorazione di prezzo / Special colors with upcharge / Couleurs spéciales avec supplément de prix / Sonderfarben gegen einem Aufpreis / Coloraciones especiales disponibles por un cargo adicional

Questo campionario deve essere considerato solo come guida indicativa del colore e non può essere utilizzato come riferimento originale per la produzione e la valutazione di superfici colorate.

This sample should only be considered as an indicative colour guide and cannot be used as an original reference for the production and assessment of colored surfaces.























Ce nuancier ne sert qu'à donner une idée des différents coloris et ne doit en aucun cas être utilisé comme référence originale pour la production et l'évaluation des surfaces colorées.

Diese Farbmuster sind unverbindlich und können vom Original Farbton der hergestellten Oberflächen abweichen.

Esta muestra de colores debe considerarse sólo como una guía indicativa del color, y no puede utilizarse como referencia original para la producción y evaluación de las superficies pintadas.

COLORE SOTTOPIANO / Undercounter colors / Couleur sous plan / Farbe Unterbau / Color debajo de la encimera

Finiture verniciate / Painted finishes / Finitions peintes / Lackierten Ausführungen / Acabados pintados

| | | | |
|---|---|--|---|
|  |  |  |  |
| BIANCO Loran | APRICOT | RAL 1018 | RAL 1023 |
|  |  |  |  |
| RAL 3016 | RAL 4002 | RAL 5000 | RAL 5002 |
|  |  |  |  |
| RAL 5010 | RAL 5012 | RAL 5014 | RAL 5022 |
|  |  |  |  |
| RAL 6000 | RAL 6019 | RAL 6027 | RAL 7045 |
|  |  |  |  |
| 602 PLA | C3526 | RAL 9005 | SILVER Loran |
|  |  | | |
| RAL 7006 | RAL 9007 | | |

COLORI PIANI IN VETRO / Colors of the glass tops / Couleurs des plans en verre / Farben der Glasarbeitsplatten / Colores de las encimeras de vidrio

Vetro extra-chiaro / Extra clear glass / Verre transparent / Transparenet Glas / Vidrio transparente

| | | | | | | |
|---|---|---|---|--|---|---|
|  |  |  |  |  |  |  |
| TURCHESE | LIMONE | VERDE ACQUA | VERDE | GIALLO | AZZURRO MEDITERRANEO | GLICINE |
|  |  |  |  |  |  |  |
| CELESTE | BLU CINA | ROSSO GRANATA | ROSSO VENEZIANO | SALMONE | GIALLO NEVADA | BIANCO |

Questo campionario deve essere considerato solo come guida indicativa del colore e non può essere utilizzato come riferimento originale per la produzione e la valutazione di superfici colorate.

This sample should only be considered as an indicative colour guide and cannot be used as an original reference for the production and assessment of colored surfaces.

Ce nuancier ne sert qu'à donner une idée des différents coloris et ne doit en aucun cas être utilisé comme référence originale pour la production et l'évaluation des surfaces colorées.

Diese Farbmuster sind unverbindlich und können vom Original Farbtönen der hergestellten Oberflächen abweichen.

Esta muestra de colores debe considerarse sólo como una guía indicativa del color, y no puede utilizarse como referencia original para la producción y evaluación de las superficies pintadas.

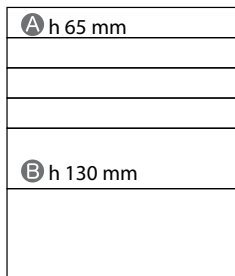
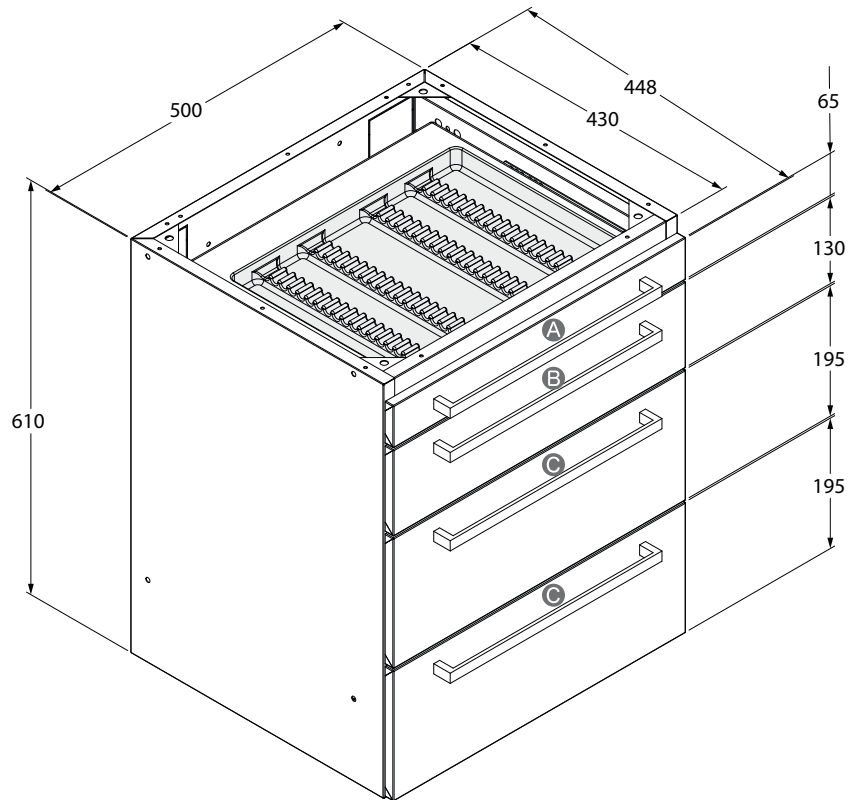

Cassetto
Drawers / Tiroirs
Schubladen / Cajones



Cassetto
Drawers / Tiroirs
Schubladen / Cajones

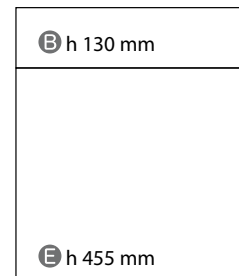

Cassetto + anta
Drawer + door / Tiroir +
porte / Schublade + Tür
Cajon + puerta

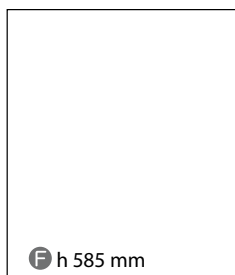

Anta / Sottolavello
Door / Sink unit
Porte / Module lavabo
Tür / Waschbeckenschrank
Puerta / Modulo bajo lavabo

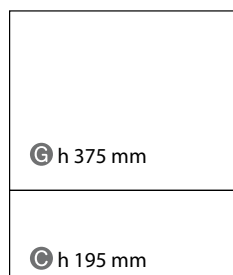

Anta a ribalta
Hide-away door
Porte basculante
Versenkbare Tür
Puerta escamoteable

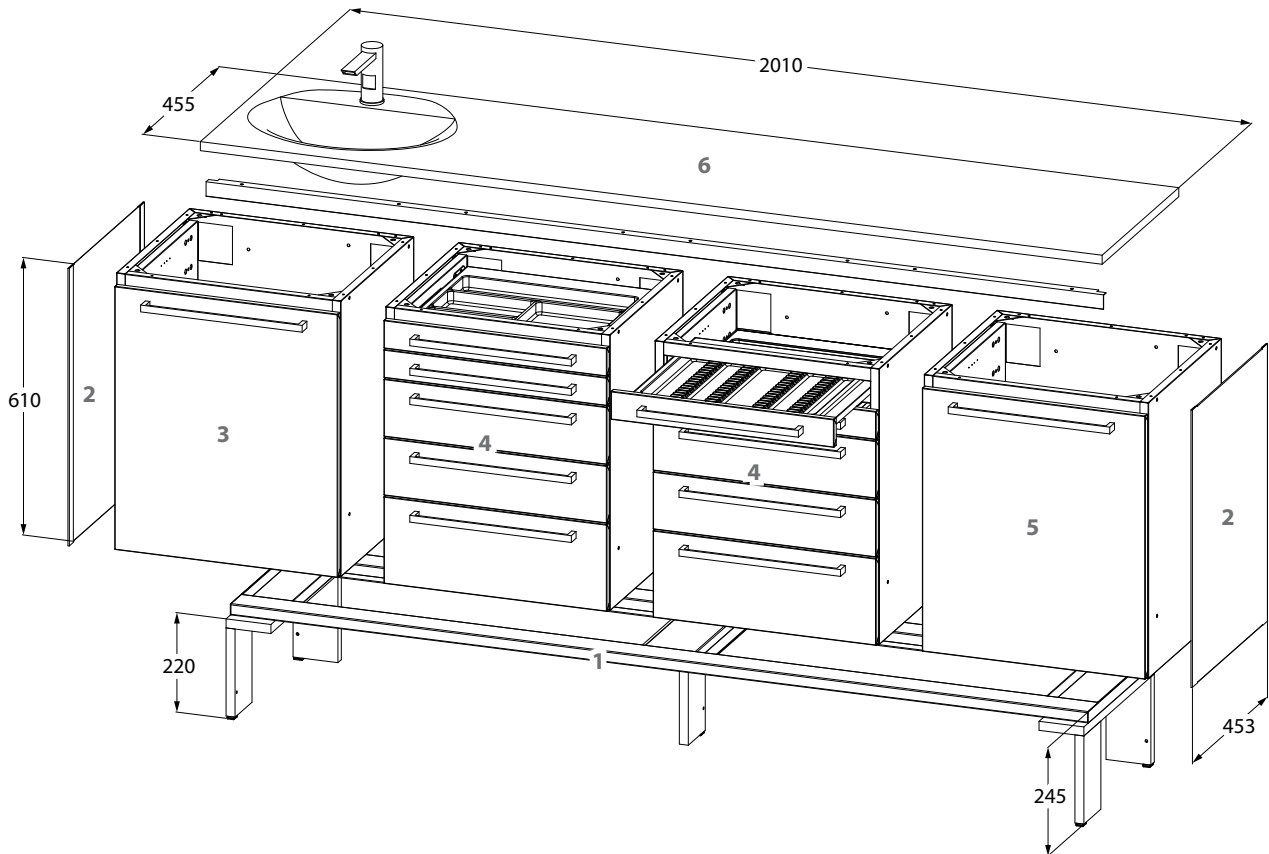

MOBILE LOOK

- 1 Supporto a pavimento
- 2 Fianco laterale
- 3 Mobile lavello
- 4 Mobile con 5 cassetti: 2 A, 2 B e 1 C
- 5 Mobile con anta e due ripiani interni
- 6 Piano con lavello sx

H Sottopiano 860 mm

UNIT LOOK

- 1 Floor support
- 2 Lateral side
- 3 Sink unit
- 4 Unit with 5 drawers: 2 A, 2 B and 1 C
- 5 Unit with door and 2 interior shelves
- 6 Top with sink on the left side

H Under the top 860 mm

MOBILIER LOOK

- 1 Support au sol
- 2 Panneau latéral
- 3 Module lavabo
- 4 Module avec 5 tiroirs: 2 A + 2 B + 1 C
- 5 Module avec porte et 2 étagères internes
- 6 Plan avec évier à gauche

H Sous plan de travail 860 mm

LOOK-MÖBEL

- 1 Bodengestell
- 2 Seitenwand
- 3 Waschbeckenschrank
- 4 Schrank mit 5 Schubladen: 2 A + 2 B + 1 C
- 5 Schrank mit Tür und 2 Einlegeböden
- 6 Arbeitsplatte mit Waschbecken links

H Unter der Arbeitsplatte 860 mm

MUEBLE LOOK

- 1 Soporte de pie
- 2 Panel lateral
- 3 Módulo bajo lavabo
- 4 Módulo con 5 cajones: 2 A + 2 B + 1 C
- 5 Módulo con puerta y dos estantes interiores
- 6 Encimera con lavabo izq.

A Bajo encimera 860 mm

Sistema di aggancio versione sospesa

Coupling system for wall support

Système d'accrochage pour le support au mur

Kupplungssystem für die Wandbefestigung

Placa de soporte para el soporte en pared

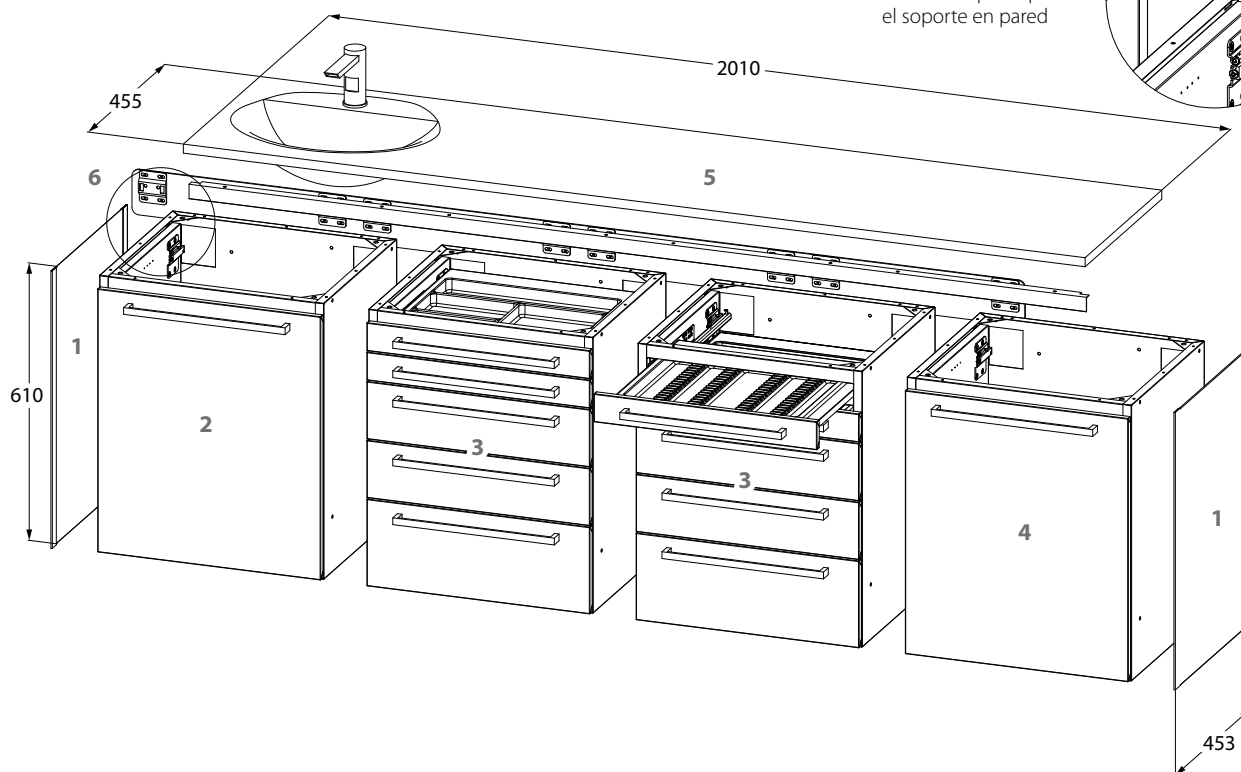
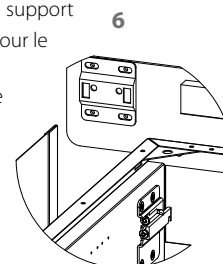

MOBILE LOOK

- 1 Fianco laterale
- 2 Mobile lavello
- 3 Mobile con 5 cassetti: 2 A, 2 B e 1 C
- 4 Mobile con anta e due ripiani interni
- 5 Piano con lavello sx
- 6 Sistema di aggancio per versione a muro

H Sottopiano 860 mm

UNIT LOOK

- 1 Lateral side
- 2 Sink unit
- 3 Unit with 5 drawers: 2 A, 2 B and 1 C
- 4 Unit with door and 2 interior shelves
- 5 Top with sink on the left side
- 6 Coupling system for wall support

H Under the top 860 mm

MOBILIER LOOK

- 1 Panneau latéral
- 2 Module lavabo
- 3 Module avec 5 tiroirs: 2 A + 2 B + 1 C
- 4 Module avec porte et 2 étagères internes
- 5 Plan avec évier à gauche
- 6 Système d'accrochage pour le support au mur

H Sous plan de travail 860 mm

LOOK-MÖBEL

- 1 Seitenwand
- 2 Waschbeckenschrank
- 3 Schrank mit 5 Schubladen: 2 A + 2 B + 1 C
- 4 Schrank mit Tür und 2 Einlegeböden
- 5 Arbeitsplatte mit Waschbecken links
- 6 Kupplungssystem für die Wandbefestigung

H Unter der Arbeitsplatte 860 mm

MUEBLE LOOK

- 1 Panel lateral
- 2 Módulo bajo lavabo
- 3 Módulo con 5 cajones: 2 A + 2 B + 1 C
- 4 Módulo con puerta y dos estantes interiores
- 5 Encimera con lavabo izq.
- 6 Placa de soporte para el soporte en pared

A Bajo encimera 860 mm

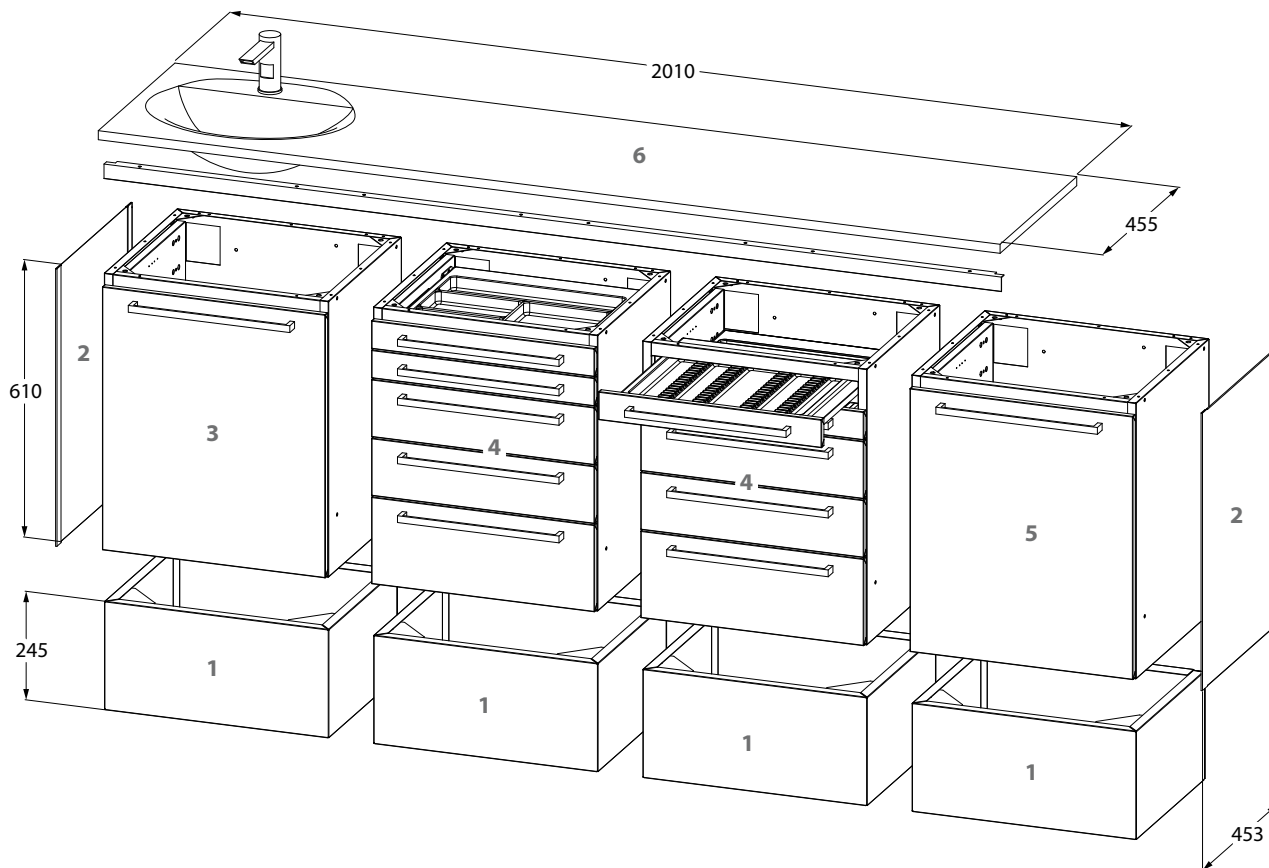

MOBILE LOOK

- 1 Basamento
- 2 Fianco laterale
- 3 Mobile lavello
- 4 Mobile con 5 cassetti: 2 A, 2 B e 1 C
- 5 Mobile con anta e due ripiani interni
- 6 Piano con lavello sx

H Sottopiano 860 mm

UNIT LOOK

- 1 Base unit
- 2 Lateral side
- 3 Sink unit
- 4 Unit with 5 drawers: 2 A, 2 B and 1 C
- 5 Unit with door and 2 interior shelves
- 6 Top with sink on the left side

H Under the top 860 mm

MOBILIER LOOK

- 1 Base
- 2 Panneau latéral
- 3 Module lavabo
- 4 Module avec 5 tiroirs: 2 A + 2 B + 1 C
- 5 Module avec porte et 2 étagères internes
- 6 Plan avec évier à gauche

H Sous plan de travail 860 mm

LOOK-MÖBEL

- 1 Sockel
- 2 Seitenwand
- 3 Waschbeckenschrank
- 4 Schrank mit 5 Schubladen: 2 A + 2 B + 1 C
- 5 Schrank mit Tür und 2 Einlegeböden
- 6 Arbeitsplatte mit Waschbecken links

H Unter der Arbeitsplatte 860 mm

MUEBLE LOOK

- 1 Base
- 2 Panel lateral
- 3 Módulo bajo lavabo
- 4 Módulo con 5 cajones: 2 A + 2 B + 1 C
- 5 Módulo con puerta y dos estantes interiores
- 6 Encimera con lavabo izq.

A Bajo encimera 860 mm

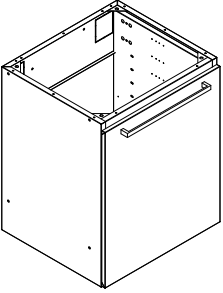
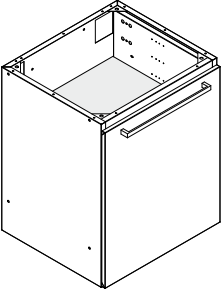
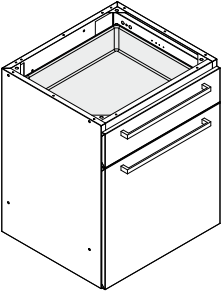
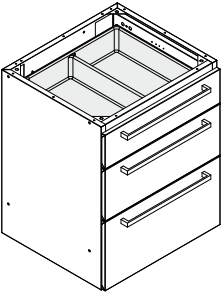
| | Descrizione / Description Description / Beschreibung / Descripción | Apertura Opening / Ouverture Öffnung / Apertura | M³ Kg | Articolo Item / Article Artikel / Artículo |
|--|--|--|-----------------------------------|---|
|  <p>L 500 x P 448 x H 610 mm</p> | <p>MODULO sottolavello con anta "LLA" o con cassettone estraibile "LLC", con portarifiuti interno</p> <p>Sink unit with door "LLA" or pullout drawer "LLC", with rubbish bin</p> <p>Module lavabo avec porte "LLA" ou grand tiroir extractible "LLC", avec poubelle</p> <p>Waschbeckenschrank mit Tür "LLA" oder Schublade "LLC", mit Abfalleimer</p> <p>Módulo lavabo con puerta "LLA" o cajon "LLC", con cubo de basura</p> | Maniglia | 0,25 | LLAM |
| | | Handle | 24,2 | |
| | | Poignée | 0,25 | LLCM |
| | | Griff | 28,7 | |
| | | Tirador | 0,25 | LLAP |
| | 24 | | | |
| | 0,25 | LLCP | | |
| Push-Pull | 28,5 | | | |
|  <p>L 500 x P 448 x H 610 mm</p> | <p>MODULO con anta e due ripiani interni</p> <p>Unit with door and 2 interior shelves</p> <p>Module avec porte et 2 étagères internes</p> <p>Schrank mit Tür und 2 Einlegeböden</p> <p>Módulo con puerta y dos estantes interiores</p> | Maniglia | 0,25 | LPAM |
| | | Handle | 23 | |
| | | Poignée | 0,25 | LPAP |
| | | Griff | 22,8 | |
| | | Tirador | 0,25 | |
| Push-Pull | 22,8 | | | |
|  <p>L 500 x P 448 x H 610 mm</p> | <p>MODULO con cassetto B e anta con 1 ripiano interno</p> <p>Unit with drawer B and door with an interior shelf</p> <p>Module avec 1 tiroir B et porte avec 1 étagère à l'intérieur</p> <p>Schrank mit 1 Schublade B und Tür mit 1 Einlegeboden</p> <p>Módulo con cajón B y puerta con 1 estante interior</p> <p>Bacinelle / Trays / Intérieurs de tiroir Einsätze / Cubetas: 1xLBB1</p> | Maniglia | 0,25 | LPBM |
| | | Handle | 27,5 | |
| | | Poignée | 0,25 | LPBP |
| | | Griff | 27,1 | |
| | | Tirador | 0,25 | |
| Push-Pull | 27,1 | | | |
|  <p>L 500 x P 448 x H 610 mm</p> | <p>MODULO con 3 cassetti: 1 B, 1 C e 1 D</p> <p>Unit with 3 drawers: 1 B, 1 C and 1 D</p> <p>Module avec 3 tiroirs: 1 B, 1 C et 1 D</p> <p>Schrank mit 3 Schubladen: 1 B, 1 C und 1 D</p> <p>Módulo con 3 cajones: 1 B, 1 C y 1 D</p> <p>Bacinelle / Trays / Intérieurs de tiroir / Einsätze / Bandejas: 1xLBB2, 2xLBC1</p> | Maniglia | 0,25 | L3AM |
| | | Handle | 30,4 | |
| | | Poignée | 0,25 | L3AP |
| | | Griff | 29,8 | |
| | | Tirador | 0,25 | |
| Push-Pull | 29,8 | | | |

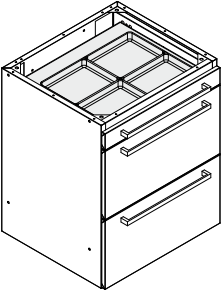
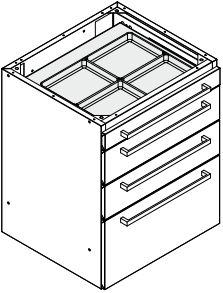
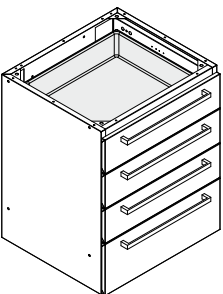
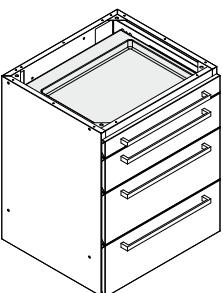
| | Descrizione / Description Description / Beschreibung / Descripción | Apertura Opening / Ouverture Öffnung / Apertura | M³ Kg | Articolo Item / Article Artikel / Artículo |
|---|--|---|-----------------------------------|---|
|  <p>MODULO con 3 cassetti: 1 A e 2 D Unit with 3 drawers: 1 B and 2 D Module avec 3 tiroirs: 1 B et 2 D Schrank mit 3 Schubladen: 1 B und 2 D Módulo con 3 cajones: 1 B y 2 D</p> <p>Bacinelle / Trays / Intérieurs de tiroir / Einsätze / Bandejas: 1xLBA3, 2xLBC1</p> | <p>L 500 x P 448 x H 610 mm</p> | <p>Maniglia Handle Poignée Griff Tirador</p> | <p>0,25 30,2</p> | L3BM |
| | | <p>Push-Pull</p> | <p>0,25 29,6</p> | L3BP |
|  <p>MODULO con 4 cassetti: 1 A, 2 B e 1 D Unit with 4 drawers: 1 A, 2 B and 1 D Module avec 4 tiroirs: 1 A, 2 B et 1 D Schrank mit 4 Schubladen: 1 A, 2 B und 1 D Módulo con 4 cajones: 1 A, 2B y 1 D</p> <p>Bacinelle / Trays / Intérieurs de tiroir / Einsätze / Bandejas: 1xLBA3, 1xLBB1, 1xLBB2, 1xLBC1</p> | <p>L 500 x P 448 x H 610 mm</p> | <p>Maniglia Handle Poignée Griff Tirador</p> | <p>0,25 33,2</p> | L4AM |
| | | <p>Push-Pull</p> | <p>0,25 32,4</p> | L4AP |
|  <p>MODULO con 4 cassetti: 3 B e 1 C Unit with 4 drawers: 3 B and 1 C Module avec 4 tiroirs: 3 B et 1 C Schrank mit 4 Schubladen: 3 B und 1 C Módulo con 4 cajones: 3 B y 1 C</p> <p>Bacinelle / Trays / Intérieurs de tiroir / Einsätze / Bandejas: 1xLBB1, 1xLBB2, 1xLBB3, 1xLBC1</p> | <p>L 500 x P 448 x H 610 mm</p> | <p>Maniglia Handle Poignée Griff Tirador</p> | <p>0,25 33,4</p> | L4BM |
| | | <p>Push-Pull</p> | <p>0,25 32,6</p> | L4BP |
|  <p>MODULO con 4 cassetti: 1 A, 1 B e 2 C Unit with 4 drawers: 1 A, 1 B and 2 C Module avec 4 tiroirs: 1 A, 1 B et 2C Schrank mit 4 Schubladen: 1 A, 1 B und 2 C Módulo con 4 cajones: 1 A, 1 B y 2 C</p> <p>Bacinelle / Trays / Intérieurs de tiroir / Einsätze / Bandejas: 1xLBA2, 1xLBB3, 2xLBC1</p> | <p>L 500 x P 448 x H 610 mm</p> | <p>Maniglia Handle Poignée Griff Tirador</p> | <p>0,25 37,8</p> | L4CM |
| | | <p>Push-Pull</p> | <p>0,25 36,8</p> | L4CP |

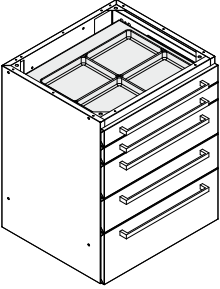
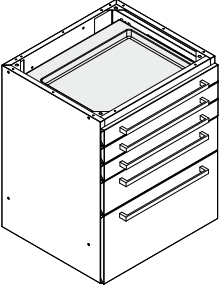
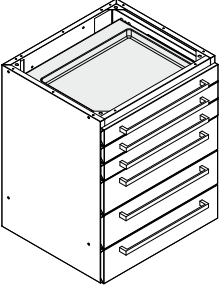
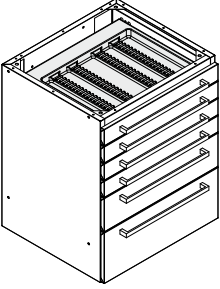
| | Descrizione / Description Description / Beschreibung / Descripción | Apertura Opening / Ouverture Öffnung / Apertura | M³ Kg | Articolo Item / Article Artikel / Artículo |
|--|---|---|-----------------------------------|---|
|  <p>L 500 x P 448 x H 610 mm</p> | <p>MODULO con 5 cassetti: 2 A, 2 B e 1 C Unit with 5 drawers: 2 A, 2 B and 1 C Module avec 5 tiroirs: 2 A, 2 B et 1 C Schrank mit 5 Schubladen: 2 A, 2 B und 1 C Módulo con 5 cajones: 2 A, 2 B y 1 C</p> <p>Bacinelle / Trays / Intérieurs de tiroir Einsätze / Bandejas: 1xLBA3, 1xLBA4, 1xLBB1, 1xLBB2, 1xLBC1</p> | <p>Maniglia Handle Poignée Griff Tirador</p> | <p>0,25 ----- 36</p> | L5AM |
| | | <p>Push-Pull</p> | <p>0,25 ----- 35</p> | L5AP |
|  <p>L 500 x P 448 x H 610 mm</p> | <p>MODULO con 5 cassetti: 3 A, 1 B e 1 D Unit with 5 drawers: 3 A, 1 B and 1 D Module avec 5 tiroirs: 3 A, 1 B et 1 D Schrank mit 5 Schubladen: 3 A, 1 B und 1 D Módulo con 5 cajones: 3 A, 1 B y 1 D</p> <p>Bacinelle / Trays / Intérieurs de tiroir Einsätze / Bandejas: 1xLBA2, 1xLBA3, 1xLBA4, 1xLBB3, 1xLBC1</p> | <p>Maniglia Handle Poignée Griff Tirador</p> | <p>0,25 ----- 35,8</p> | L5BM |
| | | <p>Push-Pull</p> | <p>0,25 ----- 34,8</p> | L5BP |
|  <p>L 500 x P 448 x H 610 mm</p> | <p>MODULO con 6 cassetti: 3 A e 3 B Unit with 6 drawers: 3 A and 3 B Module avec 6 tiroirs: 3 A et 3 B Schrank mit 6 Schubladen: 3 A und 3 B Módulo con 6 cajones: 3 A y 3 B</p> <p>Bacinelle / Trays / Intérieurs de tiroir / Einsätze / Bandejas: 1xLBA2, 1xLBA3, 1xLBA4, 1xLBB1, 1xLBB2, 1xLBB4</p> | <p>Maniglia Handle Poignée Griff Tirador</p> | <p>0,25 ----- 38,8</p> | L6AM |
| | | <p>Push-Pull</p> | <p>0,25 ----- 37,6</p> | L6AP |
|  <p>L 500 x P 448 x H 610 mm</p> | <p>MODULO con 6 cassetti: 4 A, 1 B e 1 C Unit with 6 drawers: 4 A, 1 B and 1 C Module avec 6 tiroirs: 4 A, 1 B et 1 C Schrank mit 6 Schubladen: 4 A, 1 B und 1 C Módulo con 6 cajones: 4 A, 1 B y 1 C</p> <p>Bacinelle / Trays / Intérieurs de tiroir / Einsätze / Bandejas: 1xLBA1, 1xLBA2, 1xLBA3, 1xLBA4, 1xLBB4, 1xLBC1</p> | <p>Maniglia Handle Poignée Griff Tirador</p> | <p>0,25 ----- 38,6</p> | L6BM |
| | | <p>Push-Pull</p> | <p>0,25 ----- 37,4</p> | L6BP |

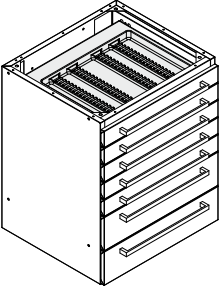
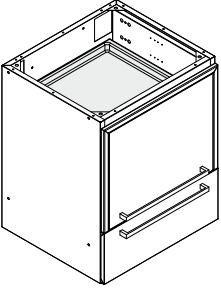
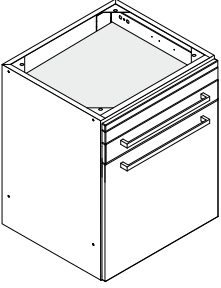
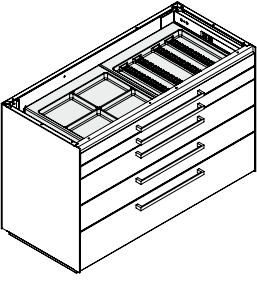
| | Descrizione / Description Description / Beschreibung / Descripción | Apertura Opening / Ouverture Öffnung / Apertura | M ³ Kg | Articolo Item / Article Artikel / Artículo |
|---|--|---|--------------------------------|--|
|  <p>L 500 x P 448 x H 610 mm</p> | <p>MODULO con 7 cassetti: 5 A e 2 B Unit with 7 drawers: 5 A and 2 B Module avec 7 tiroirs: 5 A et 2 B Schrank mit 7 Schubladen: 5 A et 2 B Módulo con 7 cajones: 5 A y 2 B</p> <p>Bacinelle / Trays / Intérieurs de tiroir Einsätze / Bandejas: 1xLBA1, 2xLBA2, 1xLBA3, 1xLBA4, 1xLBB3, 1xLBB4</p> | <p>Maniglia Handle Poignée Griff Tirador</p> | <p>0,25 ----- 41,4</p> | L7AM |
| | | <p>Push-Pull</p> | <p>0,25 ----- 40</p> | L7AP |
|  <p>L 500 x P 448 x H 610 mm</p> | <p>MODULO con anta a ribalta con 2 ripiani estraibili per apparecchiature + ciabatta con 4 prese di corrente e cassetto C Unit with hide-away door equipped with 2 apparatus storage shelves + 4 Schuko sockets and 1 drawer C Module avec porte basculante avec 2 tirettes pour appareils + 4 prises de courant Schuko et 1 tiroir C Schrank mit versenkbarer Tür mit 2 Geräteeinlagen + 4 Schuko-Steckdosen und 1 Schublade C Módulo con puerta plegable con 2 estantes extraíbles para equipos + regleta con 4 tomas de corriente Schuko y cajón C</p> <p>Bacinelle / Trays / Intérieurs de tiroir Einsätze / Bandejas: 1xLBC1</p> | <p>Maniglia Handle Poignée Griff Tirador</p> | <p>0,25 ----- 30</p> | LRAM |
| | | <p>Push-Pull</p> | <p>0,25 ----- 29,6</p> | LRAP |
|  <p>L 500 x P 448 x H 610 mm</p> | <p>MODULO PC con cassetto A per tastiera (L 385 - H 30 mm max), 1 cassetto A e anta, con schiena aperta Unit for PC with 1 drawer A for keyboard (L - H), 1 drawer A and door, open back Module pour PC avec 1 tiroir A pour clavier (L - H), 1 tiroir A et porte, ouvert derrière Schrank für PC mit 1 Schublade A für Tastatur (L - H), 1 Schublade A und Tür, Rückwand geöffnet Módulo PC con 1 cajón A porta teclado (L - H), 1 cajón A y puerta, con panel trasero abierto</p> <p>Bacinelle / Trays / Intérieurs de tiroir Einsätze / Bandejas: 1xLBA2</p> | <p>Maniglia Handle Poignée Griff Tirador</p> | <p>0,25 ----- 24</p> | LPCM |
| | | <p>Push-Pull</p> | <p>0,25 ----- 23,6</p> | LPCP |
|  <p>L 1000 x P 448 x H 610 mm</p> | <p>MODULO con 5 cassetti: 2 A, 2 B e 1 C Unit with 5 drawers: 2 A, 2 B and 1 C Module avec 5 tiroirs: 2 A, 2 B et 1 C Schrank mit 5 Schubladen: 2 A, 2 B und 1 C Módulo con 5 cajones: 2 A, 2 B y 1 C</p> <p>Bacinelle / Trays / Intérieurs de tiroir Einsätze / Bandejas: 2xLBA3, 2xLBA4, 2xLBB1, 2xLBB2, 2xLBC1</p> | <p>Maniglia Handle Poignée Griff Tirador</p> | <p>0,55 ----- 61</p> | L5AM2 |
| | | <p>Push-Pull</p> | <p>0,55 ----- 60</p> | L5AP2 |

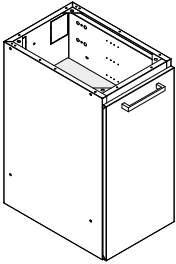
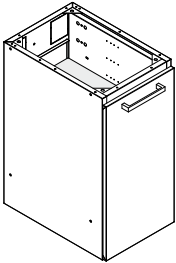
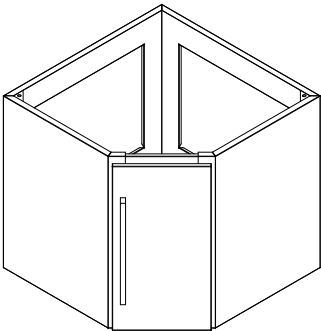
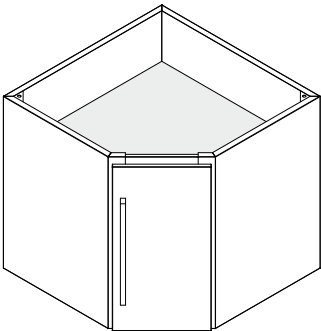
| | Descrizione / Description Description / Beschreibung / Descripción | Apertura Opening / Ouverture Öffnung / Apertura | M³ Kg | Articolo Item / Article Artikel / Artículo |
|--|--|---|-----------------------------------|---|
|  <p>L 300/400 x P 448 x H 610 mm</p> | <p>MODULO con anta e due ripiani interni</p> <p>Unit with door and 2 interior shelves Module avec porte et 2 étagères internes Schrank mit Tür und 2 Einlegeböden Módulo con puerta y dos estantes interiores</p> | <p>Maniglia Handle Poignée Griff Tirador</p> | <p>0,25 ----- 17</p> | <p>LPDM (L. 300 mm)</p> |
| | | <p>Push-Pull</p> | <p>0,25 ----- 16,9</p> | <p>LPDP (L. 300 mm)</p> |
|  <p>L 300 x P 448 x H 610 mm</p> | <p>MODULO con anta e due ripiani interni, con schiena aperta</p> <p>Unit with door and 2 interior shelves, open back Module avec porte et 2 étagères internes, ouvert derrière Schrank mit Tür und 2 Einlegeböden, Rückwand geöffnet Módulo con puerta y dos estantes interiores, con panel trasero abierto</p> | <p>Maniglia Handle Poignée Griff Tirador</p> | <p>0,25 ----- 16,5</p> | <p>LPEM</p> |
| | | <p>Push-Pull</p> | <p>0,25 ----- 16,4</p> | <p>LPEP</p> |
|  <p>L 700 x P 700 x H 610 mm</p> | <p>MODULO angolare sottolavello con anta e portarifiuti interno</p> <p>Corner sink unit with door and rubbish bin Module lavabo d'angle avec porte et poubelle Eckwaschbeckenschrank mit Tür und Abfalleimer Módulo angular lavabo con puerta y cubo de basura</p> | <p>Maniglia Handle Poignée Griff Tirador</p> | <p>0,50 ----- 19</p> | <p>LAAM</p> |
| | | <p>Push-Pull</p> | <p>0,50 ----- 18,8</p> | <p>LAAP</p> |
|  <p>L 700 x P 700 x H 610 mm</p> | <p>MODULO angolare con anta e 1 ripiano interno</p> <p>Corner unit with door and 1 interior shelf Module d'angle avec porte et 1 étagère interne Eckschrank mit Tür und 1 Einlegeboden Módulo angular con puerta y estante interior</p> | <p>Maniglia Handle Poignée Griff Tirador</p> | <p>0,50 ----- 23,5</p> | <p>LACM</p> |
| | | <p>Push-Pull</p> | <p>0,50 ----- 23,3</p> | <p>LACP</p> |

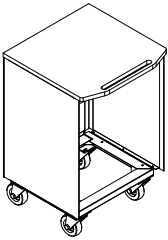
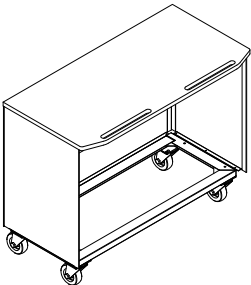
| | Descrizione / Description Description / Beschreibung / Descripción | Piano Top / Plan Arbeitsplatte / Encimera | M³ Kg | Articolo Item / Article Artikel / Artículo |
|---|---|---|-----------------------------------|---|
|  <p>L 508 x P 500 x H 740 mm</p> | <p>Kit ruote + piano sagomato bianco Castor set + shaped top Kit roues + plan façonné Rollenset + geformtem Arbeitsplatte Kit de ruedas + encimera perfilada</p> | Corian® | 0,08 ----- 24 | KRLC |
| | | Stratificato Stratified / Stratifié Schichtstoff Estratificado | 0,08 ----- 23,3 | KRLS |
| | | Vetro Glass / Verre Glas / Vidrio | 0,08 ----- 28,6 | KRLV |
|  <p>L 1008 x P 500 x H 740 mm</p> | <p>Kit ruote + piano sagomato bianco Castor set + shaped top Kit roues + plan façonné Rollenset + geformtem Arbeitsplatte Kit de ruedas + encimera perfilada</p> | Corian® | 0,16 ----- 41 | KRLC2 |
| | | Stratificato Stratified / Stratifié Schichtstoff Estratificado | 0,16 ----- 40 | KRLS2 |
| | | Vetro Glass / Verre Glas / Vidrio | 0,16 ----- 49 | KRLV2 |
| | <p>MAGGIORAZIONI per piano in vetro Additional charge for glass top Supplément de prix pour plan en verre Aufpreis für Glasarbeitsplatte Cargo adicional para encimera de vidrio</p> | Extra-chiaro Extra clear Transparent Transparent Transparente | | |
| | | Satinato Satin / Dépoli Satinert Satinado | | |

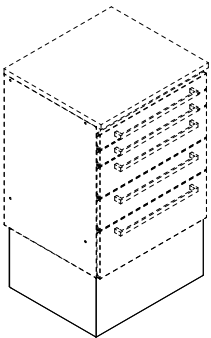
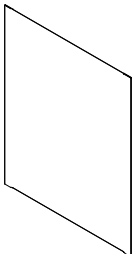
| | | | | |
|---|---|--|-------------------|-------------------|
|  | L 685 x P 685 x H 245 mm | Basamento angolare Corner base unit - Base d'angle Ecksockel - Base angular | - ----- 6,5 | LB01 |
| | L 300 x P 415 x H 245 mm | Basamento / Base unit / Base Sockel / Base: L 300 | - ----- 3 | LB02 |
| | L 400 x P 415 x H 245 mm | Basamento / Base unit / Base Sockel / Base: L 400 | - ----- 4 | LB06 |
| | L 500 x P 415 x H 245 mm | Basamento / Base unit / Base Sockel / Base: L 500 | - ----- 5 | LB03 |
| | L 1000 x P 415 x H 245 mm | Basamento / Base unit / Base Sockel / Base: L 1000 | - ----- 9 | LB05 |
|  | <p>FIANCO laterale Lateral side Panneau latéral Seitenwand Panel lateral</p> | | - ----- 3,8 | LFV45 (P. 455) |
| | | | - ----- 4,2 | LFV50 (P. 505) |
| | | Verniciato Painted / Verni Lackiert / Pintado | - ----- 5 | LFV60 (P. 600) |

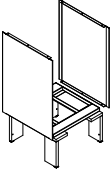
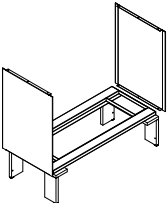
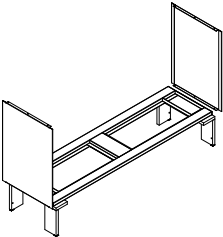
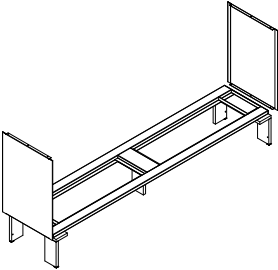
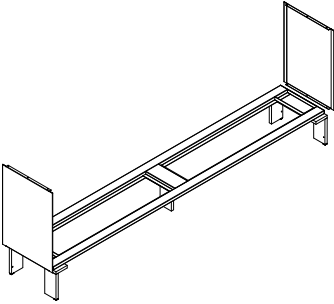
| | Descrizione / Description Description / Beschreibung / Descripción | Fianchi Sides / Côtés Seiten / Laterales | M³ Kg | Articolo Item / Article Artikel / Artículo |
|---|---|---|-----------------------------------|---|
|  | <p>SUPPORTO a pavimento per 1 modulo lineare / Modulo angolare</p> <p>Floor support for 1 unit / Corner unit Support au sol pour 1 module / Module d'angle Bodengestell für 1 Schrank / Eckschrank Soporte de pie para 1 módulo / Módulo angular</p> | Verniciato Painted / Verni Lackiert Pintado | 0,14 ----- 10 | LS1V |
| L 510 mm | | | | |
|  | <p>SUPPORTO a pavimento per 2 moduli</p> <p>Floor support for 2 units Support au sol pour 2 modules Bodengestell für 2 Schränke Soporte de pie para 2 módulos</p> | Verniciato Painted / Verni Lackiert Pintado | 0,26 ----- 15 | LS2V |
| L 1010 mm | | | | |
|  | <p>SUPPORTO a pavimento per 3 moduli</p> <p>Floor support for 3 units Support au sol pour 3 modules Bodengestell für 3 Schränke Soporte de pie para 3 módulos</p> | Verniciato Painted / Verni Lackiert Pintado | 0,35 ----- 19 | LS3V |
| L 1510 mm | | | | |
|  | <p>SUPPORTO a pavimento per 4 moduli</p> <p>Floor support for 4 units Support au sol pour 4 modules Bodengestell für 4 Schränke Soporte de pie para 4 módulos</p> | Verniciato Painted / Verni Lackiert Pintado | 0,50 ----- 25 | LS4V |
| L 2010 mm | | | | |
|  | <p>SUPPORTO a pavimento per 5 moduli</p> <p>Floor support for 5 units Support au sol pour 5 modules Bodengestell für 5 Schränke Soporte de pie para 5 módulos</p> | Verniciato Painted / Verni Lackiert Pintado | 0,54 ----- 30 | LS5V |
| L 2510 mm | | | | |

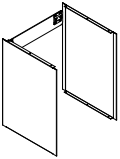
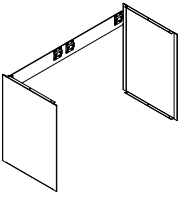
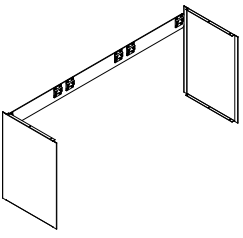
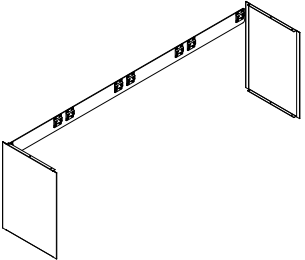
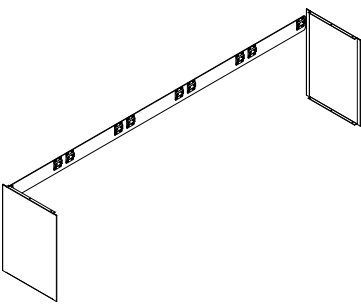
| | Descrizione / Description Description / Beschreibung / Descripción | Fianchi Sides / Côtés Seiten / Laterales | M ³ Kg | Articolo Item / Article Artikel / Artículo |
|---|---|--|-----------------------|--|
|  | SUPPORTO a muro per 1 modulo / Angolare Wall support for 1 unit / Corner unit Support au mur pour 1 module / Module d'angle Wandbefestigung für 1 Schrank / Eckschrank Soporte de pared para 1 módulo / Módulo angular | Verniciato Painted / Verni Lackiert Pintado | 0,01 ----- 9 | LM1V |
| L 510 mm | | | | |
|  | SUPPORTO a muro per 2 moduli Wall support for 2 units Support au mur pour 2 modules Wandbefestigung für 2 Schränke Soporte de pared para 2 módulos | Verniciato Painted / Verni Lackiert Pintado | 0,02 ----- 9,5 | LM2V |
| L 1010 mm | | | | |
|  | SUPPORTO a muro per 3 moduli Wall support for 3 units Support au mur pour 3 modules Wandbefestigung für 3 Schränke Soporte de pared para 3 módulos | Verniciato Painted / Verni Lackiert Pintado | 0,03 ----- 11 | LM3V |
| L 1510 mm | | | | |
|  | SUPPORTO a muro per 4 moduli Wall support for 4 units Support au mur pour 4 modules Wandbefestigung für 4 Schränke Soporte de pared para 4 módulos | Verniciato Painted / Verni Lackiert Pintado | 0,04 ----- 12 | LM4V |
| L 2010 mm | | | | |
|  | SUPPORTO a muro per 5 moduli Wall support for 5 units Support au mur pour 5 modules Wandbefestigung für 5 Schränke Soporte de pared para 5 módulos | Verniciato Painted / Verni Lackiert Pintado | 0,05 ----- 13,5 | LM5V |
| L 2510 mm | | | | |

| | Descrizione / Description Description / Beschreibung / Descripción | M³ Kg | Articolo Item / Article Artikel / Artículo |
|--|--|-----------------------------------|---|
|--|--|-----------------------------------|---|

N.B.: per le composizioni con tamponamento posteriore, il piano avrà la profondità 467 mm SENZA MAGGIORAZIONI - For compositions with closing back panel, the top will have the depth of 467 mm: WITHOUT UPCHARGE - Pour les ensembles avec cache de fermeture à l'arrière, le plan sera profond 467 mm: SANS SUPPLEMENT DE PRIX - Bei Zeilen mit Verschlussverkleidung, die Arbeitsplatte wird die Tiefe von 467 mm haben: OHNE AUFPREIS - Para las composiciones con el panel trasero, la encimera tendrá la profundidad de 467 mm: SIN CARGO ADICIONAL

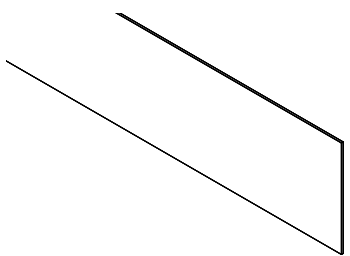
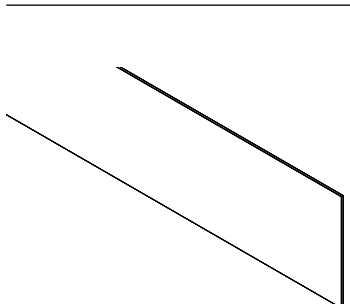
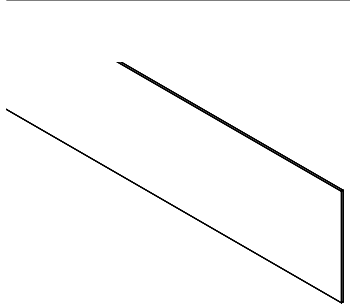
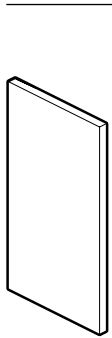
| | | | |
|---|--|-----------------|-------------|
|  <p>P 12 x H 610 mm</p> | <p>Tamponamento posteriore verniciato: al metro lineare</p> <p>Painted closing back panel: per meter Cache de fermeture à l'arrière, verni: au mètre Lackierte Verschlussverkleidung: je Meter Panel trasero, pintado: al m.</p> | <p>- 5</p> | <p>LTV</p> |
|  <p>P 12 x H 610 mm</p> | <p>Tamponamento posteriore in stratificato: al metro lineare</p> <p>Stratified closing back panel: per meter Cache de fermeture à l'arrière, en stratifié: au mètre Verschlussverkleidung aus Schichtstoff: je Meter Panel trasero, de estratificado: al m.</p> | <p>- 8</p> | <p>LTS</p> |
|  <p>P 12 x H 610 mm</p> | <p>Tamponamento posteriore in Corian®: al metro lineare</p> <p>Corian® closing back panel: per meter Cache de fermeture à l'arrière, en Corian®: au mètre Verschlussverkleidung aus Corian®: je Meter Panel trasero, de Corian®: al m.</p> | <p>- 10</p> | <p>LTC</p> |
|  <p>L 25 x P 430 x H 860 mm</p> | <p>Pannello laterale verniciato di sostegno piano</p> <p>Painted top-support side panel Panneau latéral verni, de support pour le plan Lackierte Abschlussverkleidung Panel lateral pintado para el soporte de la encimera</p> | <p>- 8</p> | <p>LSLS</p> |

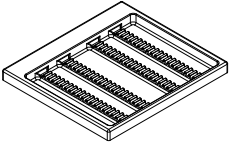
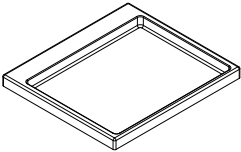
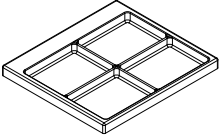
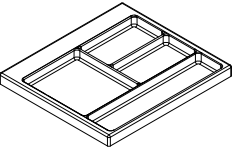
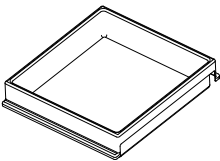
| | Descrizione / Description Description / Beschreibung / Descripción | M ³ Kg | Articolo Item / Article Artikel / Artículo |
|---|---|----------------------|--|
|  <p>BACINELLA con rastrelliera portastrumenti, per cassetto A Instrument compartment drawer tray, for drawer A Intérieur de tiroir porte-instruments, pour tiroir A Einsatz mit Instrumentenhalter, für Schublade A Bandeja porta instrumentos, para cajón A</p> <p>L 425 x P 379 x H 31 mm</p> | | - 0,5 | LBA1 |
|  <p>BACINELLA piana, per cassetto A Flat drawer tray, for drawer A Intérieur de tiroir bas, pour tiroir A Niedriger Einsatz, für Schublade A Bandeja plana, para cajón A</p> <p>L 425 x P 379 x H 31 mm</p> | | - 0,5 | LBA2 |
|  <p>BACINELLA a 4 settori, per cassetto A Drawer tray with 4 compartments, for drawer A Intérieur de tiroir à 4 secteurs, pour tiroir A 4-Fächern Einsatz, für Schublade A Bandeja con 4 sectores, para cajón A</p> <p>L 425 x P 379 x H 31 mm</p> | | - 0,5 | LBA3 |
|  <p>BACINELLA a 4 settori, per cassetto A Drawer tray with 4 compartments, for drawer A Intérieur de tiroir à 4 secteurs, pour tiroir A 4-Fächern Einsatz, für Schublade A Bandeja con 4 sectores, para cajón A</p> <p>L 425 x P 379 x H 31 mm</p> | | - 0,5 | LBA4 |
|  <p>BACINELLA piana, per cassetto B Flat drawer tray, for drawer B Intérieur de tiroir bas, pour tiroir B Niedriger Einsatz, für Schublade B Bandeja plana, para cajón B</p> <p>L 400 x P 389 x H 90 mm</p> | | - 0,9 | LBB1 |

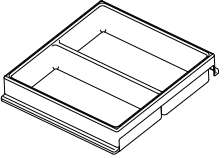
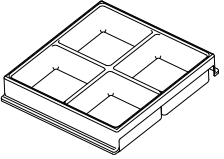
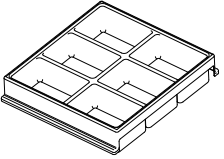
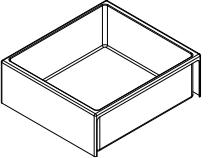
| | Descrizione / Description Description / Beschreibung / Descripción | M ³ Kg | Articolo Item / Article Artikel / Artículo |
|--|---|----------------------|--|
|  <p>L 400 x P 389 x H 90 mm</p> | <p>BACINELLA a 2 settori, per cassetto B Drawer tray with 2 compartment, for drawer B Intérieur de tiroir à 2 secteurs, pour tiroir B 2-Fächern Einsatz, für Schublade B Bandeja con 2 sectores, para cajón B</p> | - ----- 0,9 | LBB2 |
|  <p>L 400 x P 389 x H 90 mm</p> | <p>BACINELLA a 4 settori, per cassetto B Drawer tray with 4 compartments, for drawer B Intérieur de tiroir à 4 secteurs, pour tiroir B 4-Fächern Einsatz, für Schublade B Bandeja con 4 sectores, para cajón B</p> | - ----- 0,9 | LBB3 |
|  <p>L 400 x P 389 x H 90 mm</p> | <p>BACINELLA a 6 settori, per cassetto B Drawer tray with 6 compartments, for drawer B Intérieur de tiroir à 6 secteurs, pour tiroir B 6-Fächern Einsatz, für Schublade B Bandeja con 6 sectores, para cajón B</p> | - ----- 0,9 | LBB4 |
|  <p>L 423 x P 379 x H 145 mm</p> | <p>BACINELLA piana, per cassetti C e D Flat drawer tray, for drawers C and D Intérieur de tiroir bas, pour tiroirs C et D Niedriger Einsatz, für Schubladen C und D Bandeja plana, para cajones C y D</p> | - ----- 1,1 | LBC1 |

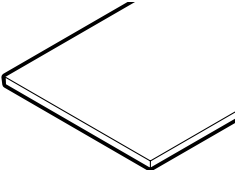
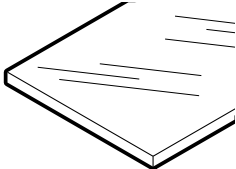
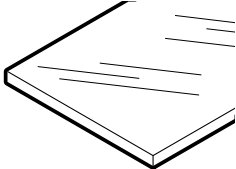
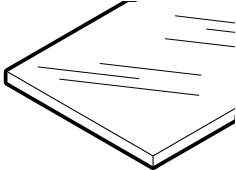
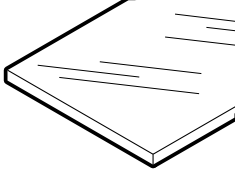
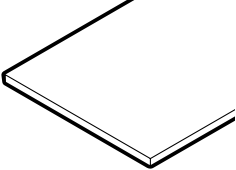
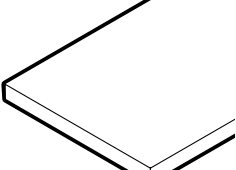
| | Descrizione / Description Description / Beschreibung / Descripción | M ³ Kg | Articolo Item / Article Artikel / Artículo |
|--|---|----------------------|--|
|  P 455 x H 12 mm | Piano in Corian® bianco: al metro lineare White Corian® top: per meter Plan en Corian® blanc: au mètre Weiß Corian® Arbeitsplatte: je Meter Encimera de Corian® blanco: al m. | - 10 | CA |
|  P 455 x H 15 mm | Piano in vetro: al metro lineare Glass top: per meter Plan en verre: au mètre Glasarbeitsplatte: je Meter Encimera de vidrio: al m. | - 17 | VA |
|  P 455 x H 15 mm | Piano in vetro satinato: al metro lineare Glass top satin: per meter Plan en verre dépoli: au mètre Satinierter Glasarbeitsplatte: je Meter Encimera de vidrio satinado: al m. | - 17 | XA |
|  P 455 x H 15 mm | Piano in vetro extra-chiaro: al metro lineare Extra clear glass top: per meter Plan en verre transparent: au mètre Transparente Glasarbeitsplatte: je Meter Encimera de vidrio transparente: al m. | - 17 | YA |
|  P 455 x H 15 mm | Piano in vetro extra-chiaro satinato: al metro lineare Extra-clear glass top satin: per meter Plan en verre transparent dépoli: au mètre Transparente satinierte Glasarbeitsplatte: je Meter Encimera de vidrio transparente satinado: al m. | - 17 | ZA |
|  P 455 x H 12 mm | Piano in stratificato bianco: al metro lineare White stratified top: per meter Plan en stratifié blanc: au mètre Weiß Schichtstoffarbeitsplatte: je Meter Encimera de estratificado blanco: al m. | - 8,6 | SA |
|  P 455 x H 20 mm P 505 x H 20 mm P 600 x H 20 mm | Piano in laminato Fenix®: al metro lineare Fenix® - laminate worktop: per meter Plan de travail en laminé Fenix®: au mètre Arbeitsplatte aus Laminat Fenix®: je Meter Encimera de laminado Fenix®: al m. | - 6 | FA (P 455 mm) |
| | | - 6,4 | FB (P 505 mm) |
| | | - 7,6 | FD (P 600 mm) |

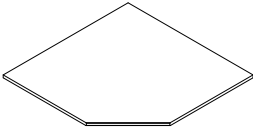
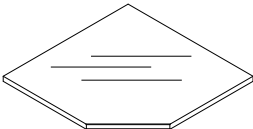
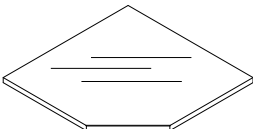
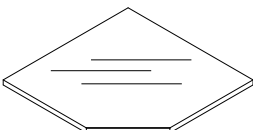
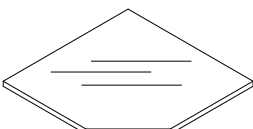
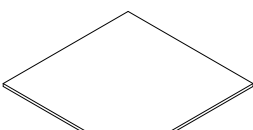
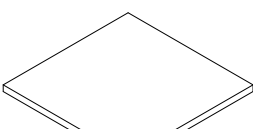
| | Descrizione / Description Description / Beschreibung / Descripción | M³ Kg | Articolo Item / Article Artikel / Artículo |
|---|--|-----------------------------------|---|
|  L 705 x P 705 x H 12 mm | Piano angolare in Corian® bianco White Corian® top for corner units Plan en Corian® blanc pour modules d'angle Weiß Corian® Arbeitsplatte für Eckschränke Encimera de Corian® blanco para módulos angulares | - 10,3 | CAV |
|  L 705 x P 705 x H 15 mm | Piano angolare in vetro Glass top for corner units Plan en verre pour modules d'angle Glasarbeitsplatte für Eckschränke Encimera de vidrio para módulos angulares | - 18 | VAV |
|  L 705 x P 705 x H 15 mm | Piano angolare in vetro satinato Glass top satin for corner units Plan en verre dépoli pour modules d'angle Satinierter Glasarbeitsplatte für Eckschränke Encimera de vidrio satinado para módulos angulares | - 18 | XAV |
|  L 705 x P 705 x H 15 mm | Piano angolare in vetro extra-chiaro Extra-clear glass top for corner units Plan en verre transparent pour modules d'angles Transparente Glasarbeitsplatte für Eckschränke Encimera de vidrio transparente para módulos angulares | - 18 | YAV |
|  L 705 x P 705 x H 15 mm | Piano angolare in vetro extra-chiaro satinato Extra-clear glass top satin for corner units Plan en verre transparent dépoli pour modules d'angles Transparente satinierter Glasarbeitsplatte für Eckschränke Encimera de vidrio trasparente satinado para módulos angulares | - 18 | ZAV |
|  L 705 x P 705 x H 12 mm | Piano angolare in stratificato bianco White stratified top for corner units Plan en stratifié blanc pour modules d'angles Weiß Schichtstoffarbeitsplatte für Eckschränke Encimera de estratificado blanco para módulos angulares | - 9 | SAV |
|  L 705 x P 705 x H 20 mm L 755 x P 755 x H 20 mm L 850 x P 850 x H 20 mm | Piano angolare in laminato Fenix® White laminate top Fenix® for corner units Plan en laminé blanc Fenix® pour modules d'angles Weiße Laminatarbeitsplatte Fenix® für Eckschränke Encimera de laminado blanco Fenix® para módulos angulares | - 6 - 7 - 9 | FAV (P 705 mm) FBV (P 755 mm) FDV (P 850 mm) |

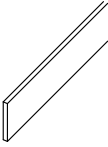
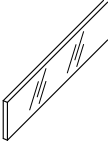
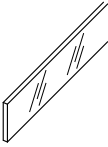
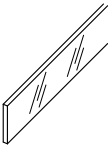
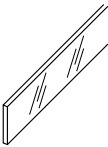
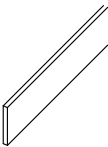
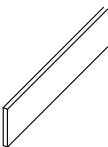
| | Descrizione / Description Description / Beschreibung / Descripción | M³ Kg | Articolo Item / Article Artikel / Artículo |
|---|---|-----------------------------------|---|
|  SP 12 x H 80 mm SP 12 x H 12 mm | Alzatina in Corian® bianco: al metro lineare White Corian® splashback: per meter Dosseret en Corian® blanc: au mètre Weiß Corian® Aufkantung: je Meter Alzada de Corian® blanco: al m. | - 1,5 | AC08 (H 80 mm) |
| | | - 0,3 | AC01 (H 12 mm) |
|  SP 15 x H 80 mm | Alzatina in vetro: al metro lineare Glass splashback: per meter Dosseret en verre: au mètre Glasaufkantung: je Meter Alzada de vidrio: al m. | - 3 | AV08 (H 80 mm) |
|  SP 15 x H 80 mm | Alzatina in vetro satinato: al metro lineare Glass splashback satin: per meter Dosseret en verre dépoli: au mètre Satinierte Glasaufkantung: je Meter Alzada de vidrio satinado: al m. | - 3 | AX08 (H 80 mm) |
|  SP 15 x H 80 mm | Alzatina in vetro extra-chiaro: al metro lineare Extra-clear glass splashback: per meter Dosseret en verre transparent: au mètre Transparente Glasaufkantung: e Meter Alzada de vidrio transparente: al m. | - 3 | AY08 (H 80 mm) |
|  SP 15 x H 80 mm | Alzatina in vetro extra-chiaro satinato: al metro lineare Extra-clear glass splashback satin: per meter Dosseret en verre transparent dépoli: au mètre Transparente satinierte Glasaufkantung: e Meter Alzada de vidrio transparente satinado: al m. | - 3 | AZ08 (H 80 mm) |
|  SP 12 x H 80 mm | Alzatina in stratificato bianco: al metro lineare White stratified splashback: per meter Dosseret en stratifié blanc: au mètre Weiß Schichtstoffaufkantung: je Meter Alzada de estratificado blanco: al m. | - 1,5 | AS08 (H 80 mm) |
|  SP 20 x H 80 mm | Alzatina in laminato Fenix®: al metro lineare Splashback laminate Fenix®: per meter Dosseret en laminè Fenix®: au mètre Aufkantung aus laminat Fenix®: je Meter Alzada de laminato Fenix®: al m. | - 1 | AF08 (H 80 mm) |

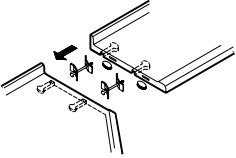
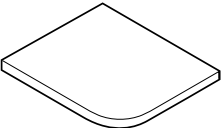
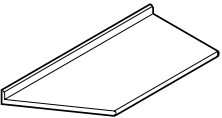
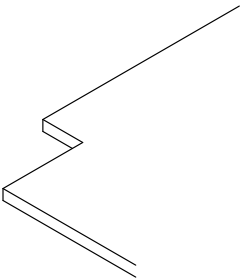

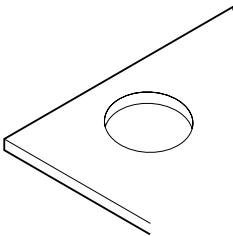
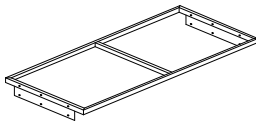
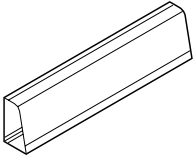
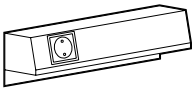
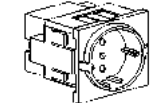
| | Descrizione / Description Description / Beschreibung / Descripción | M ³ Kg | Articolo Item / Article Artikel / Artículo |
|---|--|----------------------|--|
|  | <p>Set collegamento 2 piani laminato Worktop-connection set Set pour la liaison de 2 plans de travail Set für Zusammenbau von Arbeitsplatten Juego para la unión de las 2 encimeras</p> | | SCP |
|  | <p>Arrotondamento spigolo del piano Corner-rounding for top Angle arrondi pour le plan de travail Abgerundete Kanten der Arbeitsplatte Angulo redondeado de la encimera</p> | | |
| | Corian® | | ARC |
| | Vetro / Glass / Verre / Glas / Vidrio | | ARV |
| | Stratificato / Stratified / Stratifié / Schichtstoff / Estratificado | | ARS |
| | Laminato Fenix® / Laminata Fenix® / Laminé Fenix® / Laminat Fenix® / Laminado Fenix® | | ARP |
|  | <p>Taglio obliquo su piano Special cut of top Découpe spéciale sur le plan de travail Sonderschnitt der Arbeitsplatte Corte especial sobre la encimera</p> | | |
| | Corian® | | TSC |
| | Vetro / Glass / Verre / Glas / Vidrio | | TSV |
| | Stratificato / Stratified / Stratifié / Schichtstoff / Estratificado | | TSS |
| | Laminato Fenix® / Laminata Fenix® / Laminé Fenix® / Laminat Fenix® / Laminado Fenix® | | TSP |
|  | <p>Taglio a "L" su piano Special cut of top Découpe spéciale sur le plan de travail Sonderschnitt der Arbeitsplatte Corte especial sobre la encimera</p> | | |
| | Corian® | | T1C |
| | Vetro / Glass / Verre / Glas / Vidrio | | T1V |
| | Stratificato / Stratified / Stratifié / Schichtstoff / Estratificado | | T1S |
| | Laminato Fenix® / Laminata Fenix® / Laminé Fenix® / Laminat Fenix® / Laminado Fenix® | | T1P |

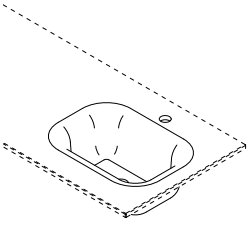
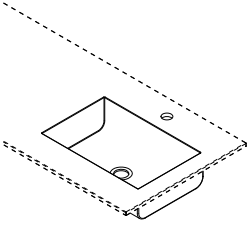
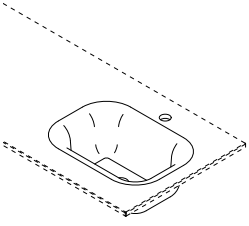
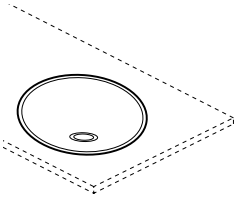
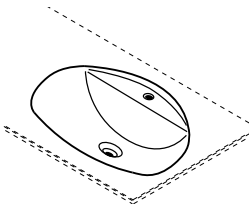
| | Descrizione / Description Description / Beschreibung / Descripción | M³ Kg | Articolo Item / Article Artikel / Artículo |
|--|---|-----------------------------------|---|
|  | <p>Foro Ø 150 mm su piano, per rifiuti Waste hole Ø 150 mm for top Trou passage déchets Ø 150 mm, pour plan Abfalloch Ø 150 mm für Arbeitsplatte Agujero Ø 150 mm para la basura, sobre encimera</p> <hr/> <p>Corian®</p> <hr/> <p>Vetro / Glass / Verre / Glas / Vidrio</p> <hr/> <p>Stratificato / Stratified / Stratifié / Schichtstoff / Estratificado</p> <hr/> <p>Laminato Fenix® / Lamine Fenix® / Laminé Fenix® / Laminat Fenix® / Laminado Fenix®</p> | | <p>FRC</p> <hr/> <p>FRV</p> <hr/> <p>FRS</p> <hr/> <p>FRT</p> |
|  | <p>Telaio supporto piano a sbalzo per piani Corian®, vetro, stratificato: al metro lineare Frame to support the top in Corian®, glass, stratified Châssis pour soutenir le plan en Corian®, verre, stratifié Rahmen für Arbeitsplatte aus Corian®, Glas, Schichtstoff Frame para apoyar las encimeras de Corian®, vidrio, estratificado</p> | | <p>STS</p> |
|  <p>P 20 x H 45 mm</p> | <p>Alzatina bianca: al metro lineare White splashback: per meter Dossieret blanc: au mètre Weiße Aufkantung: je Meter Alzada blanca: al m.</p> | <p>- 0,5</p> | <p>ALB</p> |
|  <p>P 63 x H 75 mm</p> | <p>Canalina tecnica in alluminio: al metro lineare (min. P. 505 mm) Aluminium raceway: per meter (min. D. 505 mm) Canalisation technique en aluminium: au mètre (min. P. 505 mm) Technikkanal aus Aluminium: je Meter (min. T. 505 mm) Canal técnico de aluminio: al m. (min. P. 505 mm)</p> | <p>- 1,2</p> | <p>CVE</p> |
|  | <p>Presa di corrente Schuko per canalina tecnica CVE Schuko-socket for CVE Prise de courant Schuko pour CVE Schuko-Steckdose für CVE Toma de corriente Schuko para CVE</p> | | <p>PCS</p> |

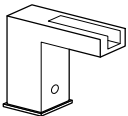
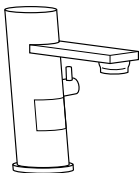
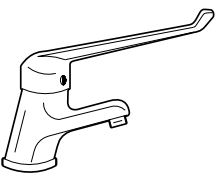
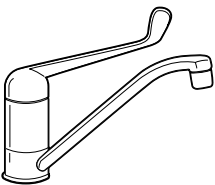
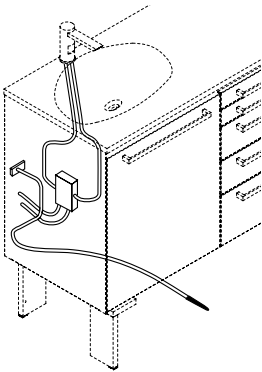
| | Descrizione / Description Description / Beschreibung / Descripción | M ³ Kg | Articolo Item / Article Artikel / Artículo |
|--|--|----------------------|--|
|  <p>L 400 x P 300 x H 130 mm</p> | <p>Lavello termoformato in Corian® Integrated thermoformed Corian® sink Evier intégré thermoformé en Corian® Integriertes tiefgezogenes Waschbecken aus Corian® Lavabo integrado termoformato de Corian®</p> | | VTC |
|  <p>L 400 x P 270 x H 195 mm</p> | <p>Lavello sottopiano in acciaio inox, per piani in Corian® e stratificato Undermount stainless steel sink, for Corian® and stratified top Evier en inox, pour plans en Corian® et stratifié Unterbauedelstahlwaschbecken, für Arbeitsplatte aus Corian® und Schichtstoff Lavabo bajo encimera de acero para encimeras de Corian® y estratificado</p> | | VFA |
|  <p>L 400 x P 300 x H 130 mm</p> | <p>Lavello integrato in vetro Integrated glass sink Evier intégré en verre Integriertes, tiefgezogenes Glaswaschbecken Lavabo integrado de vidrio</p> <p>NB: piani lineari L 2800 mm max. / Straight tops L 2800 mm max. / Plans linéaires L 2800 mm max. / Gerade Arbeitsplatte L 2800 mm max. / Encimera lineal L 2800 mm max.</p> | | VIV |
|  <p>Ø 340 mm - H 160 mm</p> | <p>Lavello a semisfera in acciaio inox soprapiano Top mounted stainless steel sink Evier en inox sur plan Aufgesetztes Edelstahlwaschbecken Lavabo de acero sobre encimera</p> <p>NB: si consiglia il rubinetto RB3 / mixer RB3 suggested / robinet RB3 conseillé / Wasserhahn RB3 empfohlen / se aconseja el grifo RB3</p> | - 1 | VAS |
|  <p>L 455 x P 405 mm</p> | <p>Lavello in ceramica a filo piano Flush ceramic bowl Evier porcelaine collée sous le plan Porzellanwaschbecken bündig mit der Arbeitsplatte Lavabo de cerámica a ras de la encimera</p> | | |
| | <p>Laminato Fenix® / Laminat Fenix® / Laminé Fenix® / Laminat Fenix® / Laminado Fenix®</p> | - 7,2 | VCF |
| | <p>Stratificato / Stratified / Stratifié / Schichtstoff / Estratificado</p> | - 7,2 | VCS |

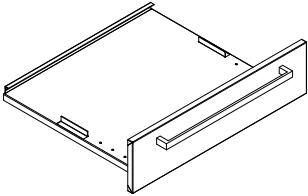
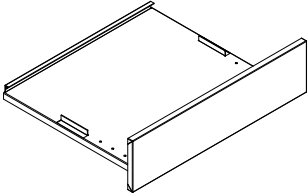
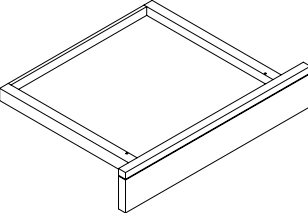
| | Descrizione / Description Description / Beschreibung / Descripción | M³ Kg | Articolo Item / Article Artikel / Artículo |
|--|--|-----------------------------------|---|
| Per lo STUDIO / For DENTAL OFFICE / - Pour le CABINET / Für PRAXIS / Por el ESTUDIO | | | |
|  | <p>Rubinetto "a cascata" con fotocellula Mixer "a cascata" with photoelectric cell Robinet électronique "a cascata" à photocellule Elektronische Wasserhahn "a cascata" mit Fozozelle Grifo "a cascada" con fotocélula</p> | - 4 | RB8 |
|  | <p>Rubinetto con fotocellula Mixer with photoelectric cell Robinet électronique à photocellule Elektronische Wasserhahn mit Fozozelle Grifo con fotocélula</p> | - 3 | RB7 |
|  | <p>Rubinetto cromato a leva lunga Chromed mixer with long lever Robinet chromé à levier long Verchromte Wasserhahn mit langem Hebel Grifo cromado con palanca larga</p> | - 1,5 | RB2 |
|  | <p>Rubinetto cromato con collo lungo e leva lunga Chromed mixer with long neck and long lever Robinet chromé à col long et levier long Verchromte Langrohr- und Langhebel-Wasserhahn Grifo cromado con caño largo y palanca larga</p> | - 1,5 | RB3 |
|  | <p>Kit comando elettromagnetico 24V ad asta 24V electromagnetic control kit Kit commande électromagnétique 24V pour l'eau Elektromagnetischer Wasserauslöser 24V Kit de control electromagnético 24V</p> | - 1 | VKEL |

| | Descrizione / Description Description / Beschreibung / Descripción | M³ Kg | Articolo Item / Article Artikel / Artículo |
|---|--|-----------------------------------|---|
|  | <p>CASSETTO con maniglia Drawer with handle Tiroir avec poignée Schublade mit Griff Cajón con tirador</p> | A) H 65 - 3,6 | LCAAM |
| | | B) H 130 - 4,6 | LCABM |
| | | C) H 195 - 5,4 | LCACM |
| | | D) H 260 - 6,2 | LCADM |
|  | <p>CASSETTO Push-Pull Drawer Push-Pull Tiroir Push-Pull Schublade Push-Pull Cajón Push-Pull</p> | A) H 65 - 3,4 | LCAAP |
| | | B) H 130 - 4,4 | LCABP |
| | | C) H 195 - 5,2 | LCACP |
| | | D) H 260 - 6 | LCADP |
|  | <p>CASSETTO per tastiera (L 385 - H 30 mm max) Drawer for keyboard (L 385 - H 30 mm) Tiroir pour clavier (L 385 - H 30 mm) Schublade für Tastatur (L 385 - H 30 mm) Cajón porta teclado (L 385 - H 30 mm)</p> | A) H 65 - 3,4 | LCAAPK |

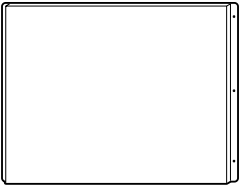
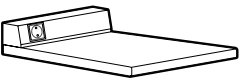
| | Descrizione / Description Description / Beschreibung / Descripción | M³ Kg | Articolo Item / Article Artikel / Artículo |
|---|--|-----------------------------------|---|
|  | <p>Pannello di chiusura da 70 a 150 mm</p> <p>Closing panel from 70 to 150 mm</p> <p>Cache de fermeture de 70 à 150 mm</p> <p>Verschlußverkleidung von 70 bis 150 mm</p> <p>Panel de cierre desde 70 hasta 150 mm</p> | | LPC1 |
| H min 610 - H max 860 mm | | | |
|  | <p>Pannello di chiusura da 160 a 250 mm</p> <p>Closing panel from 160 to 250 mm</p> <p>Cache de fermeture de 160 à 250 mm</p> <p>Verschlußverkleidung von 160 bis 250 mm</p> <p>Panel de cierre desde 160 hasta 250 mm</p> | | LPC2 |
| H min 610 - H max 860 mm | | | |
|  | <p>Pannello di chiusura ad angolo</p> <p>Corner closing panel</p> <p>Cache de fermeture pour angle</p> <p>Eckverschlußverkleidung</p> <p>Panel de cierre en ángulo</p> | | LPC3 |
| H min 610 - H max 860 mm | | | |
|  | <p>Pannello chiusura posteriore ai mobili: al metro lineare</p> <p>Furniture back panel: per meter</p> <p>Cache arrière meubles: au mètre</p> <p>Hintere Platte: je Meter</p> <p>Panel de cierre posterior: al m.</p> | | LPC4 |
| H min 610 - H max 860 mm | | | |
|  | <p>Piano estraibile con 1 presa di corrente Schuko</p> <p>Pull-out shelf with 1 Schuko socket</p> <p>Tirette avec 1 prise de courant Schuko</p> <p>Auszug ausgestattet mit 1 Schuko-Steckdose</p> <p>Estante extraíble con 1 toma de corriente Schuko</p> | - 4 | PE/3 (L 300 mm) |
| L 300/400 x P 400 x H 135 mm | | - 5 | PE/4 (L 400 mm) |

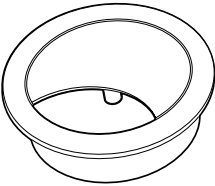
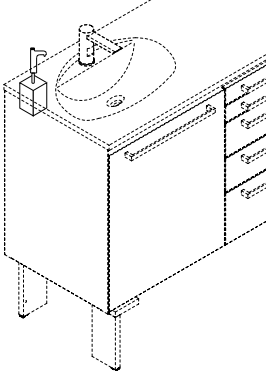
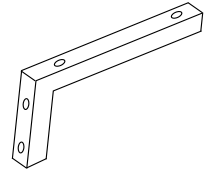
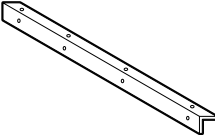
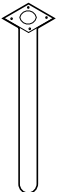
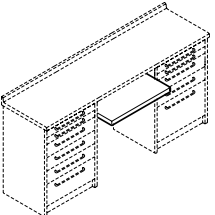
| | Descrizione / Description Description / Beschreibung / Descripción | M³ Kg | Articolo Item / Article Artikel / Artículo |
|--|---|-----------------------------------|---|
|  <p>Ø 60 mm</p> | <p>Boccola passacavo con chiusura</p> <p>Cable bush with plug</p> <p>Manchon passe-câbles avec fermeture</p> <p>Kabeldurchführung mit Verschluss</p> <p>Casquillo pasacables con cierre</p> | | BOP |
|  | <p>Distributore di sapone</p> <p>Soap dispenser</p> <p>Distributeur de savon</p> <p>Seifenspender</p> <p>Distribudor de jabón</p> | - 0,24 | DSA |
|  <p>L 40 x P 320 x H 180 mm L 40 x P 430 x H 240 mm</p> | <p>Supporto mensola in tubo quadro cromato</p> <p>Chromed shelf brackets</p> <p>Equerre chromée de support pour étagère</p> <p>Verchromte Stützbügel für Regal</p> <p>Estribo cromado de sostén de la repisa</p> | | SMC2 (P 320 mm) SMC1 (P 430 mm) |
|  <p>L 350 x P 40 x H 40 mm</p> | <p>Squadretta a "L" di sostegno piano</p> <p>"L" top bracket</p> <p>Equerre à "L" de soutien pour plan</p> <p>"L-förmige" Stützbügel für Arbeitsplatte</p> <p>Estribo en "L" de sostén de la encimera</p> | | SSL |
|  <p>H 860 mm - Ø 60</p> | <p>Supporto in tubolare per piano</p> <p>Tube top bracket</p> <p>Support en tube pour plan</p> <p>Rundrohrbeine für Arbeitsplatte</p> <p>Soporte en tubular para la encimera</p> | - 8 | LSTP |
|  <p>L 500 x P 400 x H 30 mm</p> | <p>Piano estraibile in laminato per tastiera</p> <p>Pull-out laminated top for keyboard</p> <p>Tirette en laminé pour clavier</p> <p>Ausziehbare Platte für Tastatur</p> <p>Estante extraíble de laminado para teclado</p> | - 4,5 | PPT |

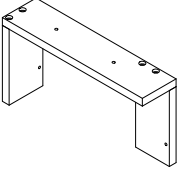
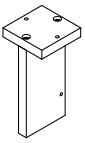
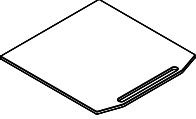
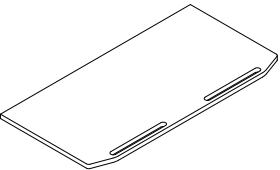
| | Descrizione / Description Description / Beschreibung / Descripción | M³ Kg | Articolo Item / Article Artikel / Artículo |
|---|---|---|---|
|  | PIEDE in alluminio Aluminium foot Pied en aluminium Aluminiumfuß Pata de aluminio | DX / RH Droite / Rechts Dcho | - 4 LPAD |
| | | SX / LH Gauche / Links Izq | - 4 LPAS |
|  | PIEDE CENTRALE in alluminio Aluminium foot Pied en aluminium Aluminiumfuß Pata de aluminio | - | 1,5 LPAC |
|  | PIANO sagomato per servomobile Shaped top for movable unit Plan façonné pour module mobile Geformte Arbeitsplatte für Rollenschrank Encimera perfilada para módulo móvil | Corian® | - 5,2 LPSC |
| | | Stratificato Stratifié / Stratifié Schichtstoff Estratificado | - 4,5 LPSS |
| | | Vetro / Glass Verre / Glas / Vidrio | - 9 LPSV |
| | | Extra-chiaro Extra clear Transparent Transparent Extra-claro | |
| | | Satinato / Satin Dépoli / Satiniert Satinado | |
|  | PIANO sagomato per servomobile Shaped top for movable unit Plan façonné pour module mobile Geformte Arbeitsplatte für Rollenschrank Encimera perfilada para módulo móvil | Corian® | - 10,4 LPSC2 |
| | | Stratificato Stratifié / Stratifié Schichtstoff Estratificado | - 9 LPSS2 |
| | | Vetro / Glass Verre / Glas / Vidrio | - 18 LPSV2 |
| | | Extra-chiaro Extra clear Transparent Transparent Extra-claro | |
| | | Satinato / Satin Dépoli / Satiniert Satinado | |

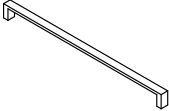
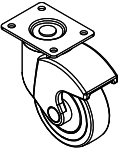
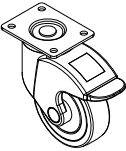
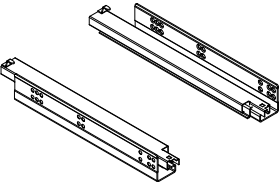
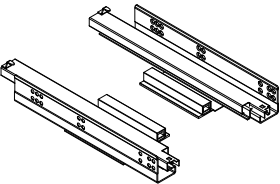
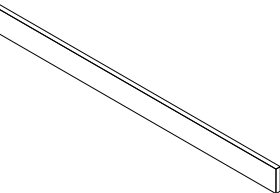
| | Descrizione / Description Description / Beschreibung / Descripción | M³ Kg | Articolo Item / Article Artikel / Artículo |
|---|--|-----------------------------------|---|
|  | MANIGLIA in alluminio per "Look" Aluminium handle for "Look" Poignée en aluminium pour "Look" Griff aus Aluminium für "Look" Tirador de aluminio para "Look" | - 0,4 | MA020 |
|  | RUOTA senza freno Castor without brake Roue sans frein Rad ohne Bremse Rueda sin freno | - 0,6 | RUO21 |
|  | RUOTA con freno Castor with brake Roue avec frein Rad mit Bremse Rueda con freno | - 0,7 | RUO22 |
|  | COPPIA DI GUIDE con rientro ammortizzato Pair of guides with soft closing Couple de glissières avec amortisseur Eine Paar Führungen mit Softeinzug Par de guías con cierre suave | - 1,7 | GUI55 |
|  | COPPIA DI GUIDE per cassetto Push-Pull Pair of guides for Push-Pull drawer Couple de glissières pour tiroir Push-Pull Eine Paar Führungen für Push-Pull Schublade Par de guías para cajón Push-Pull | - 1,9 | GUI56 |
|  | Sottopiano: al metro lineare Undercounter: per meter Sous plan: au mètre Unterbau: je meter De Baio de la encimera: al m. | - 1 | LSPV |

L 1000 x P 5 x H 25 mm

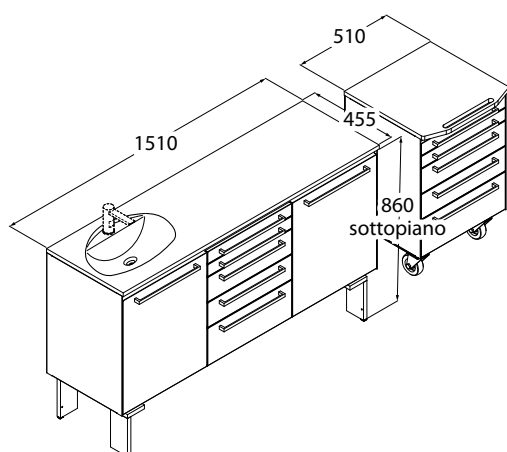

- | | | |
|---|---|-------|
| 1 | Piano in laminato Fenix® "Fenix®" - laminate worktop / Plan de travail en laminé "Fenix®" / Arbeitsplatte aus Laminat "Fenix®" / Encimera de laminado "Fenix®" | + VCF |
| 2 | Piano in stratificato Stratified top / Plan stratifié / Arbeitsplatte aus Schichtstoff / Encimera de estratificado | + VCS |
| 3 | Piano in vetro Glass top / Plan en verre Arbeitsplatte aus Glas / Encimera de vidrio | + VIV |
| 4 | Piano in Corian® Corian® top / Plan en Corian® Arbeitsplatte aus Corian® / Encimera de Corian® | + VTC |

A **Composizione / Composition**
Composition / Zusammenstellung / Composición

LLA + L5A + LPA + L5A + KR

La composizione è comprensiva di bacinelle standard. Rubinetto escluso.

Trays included. Mixer excluded

Intérieurs de tiroirs inclus. Robinet pas compris.

Standard Schubladeneinsätze sind enthalten. Armatur ist ausgeschlossen.

La composición incluye bandejas estándar. Grifo excluido.

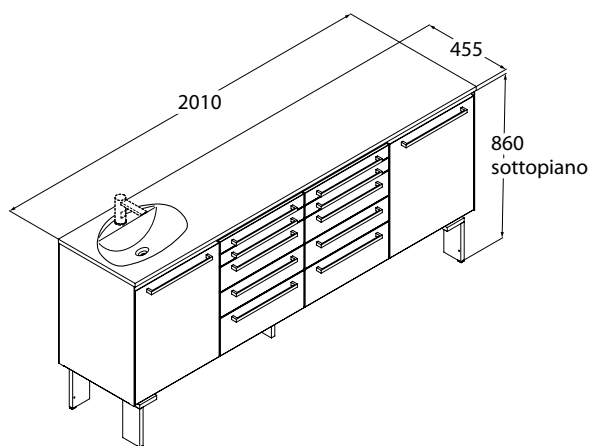

- | | | |
|---|---|-------|
| 1 | Piano in laminato Fenix® "Fenix®" - laminate worktop / Plan de travail en laminé "Fenix®" / Arbeitsplatte aus Laminat "Fenix®" / Encimera de laminado "Fenix®" | + VCF |
| 2 | Piano in stratificato Stratified top / Plan stratifié / Arbeitsplatte aus Schichtstoff / Encimera de estratificado | + VCS |
| 3 | Piano in vetro Glass top / Plan en verre Arbeitsplatte aus Glas / Encimera de vidrio | + VIV |
| 4 | Piano in Corian® Corian® top / Plan en Corian® Arbeitsplatte aus Corian® / Encimera de Corian® | + VTC |

B **Composizione / Composition**
Composition / Zusammenstellung / Composición

LLA + L5A + L5A + LPA

La composizione è comprensiva di bacinelle standard. Rubinetto escluso.

Trays included. Mixer excluded

Intérieurs de tiroirs inclus. Robinet pas compris.

Standard Schubladeneinsätze sind enthalten. Armatur ist ausgeschlossen.

La composición incluye bandejas estándar. Grifo excluido.

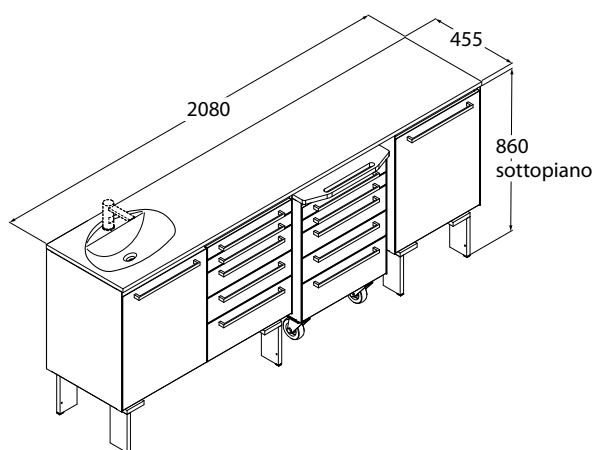

- | | | |
|----------|---|--------------|
| 1 | Piano in laminato Fenix® "Fenix®" - laminate worktop / Plan de travail en laminé "Fenix®" / Arbeitsplatte aus Laminat "Fenix®" / Encimera de laminado "Fenix®" | + VCF |
| 2 | Piano in stratificato Stratified top / Plan stratifié / Arbeitsplatte aus Schichtstoff / Encimera de estratificado | + VCS |
| 3 | Piano in vetro Glass top / Plan en verre Arbeitsplatte aus Glas / Encimera de vidrio | + VIV |
| 4 | Piano in Corian® Corian® top / Plan en Corian® Arbeitsplatte aus Corian® / Encimera de Corian® | + VTC |

C **Composizione** / Composition
Composition / Zusammenstellung / Composición

LLA + L5A + L5A + KR + LAP

La composizione è comprensiva di bacinelle standard. Rubinetto escluso.

Trays included. Mixer excluded

Intérieurs de tiroirs inclus. Robinet pas compris.

Standard Schubladeneinsätze sind enthalten. Armatur ist ausgeschlossen.

La composición incluye bandejas estándar. Grifo excluido.

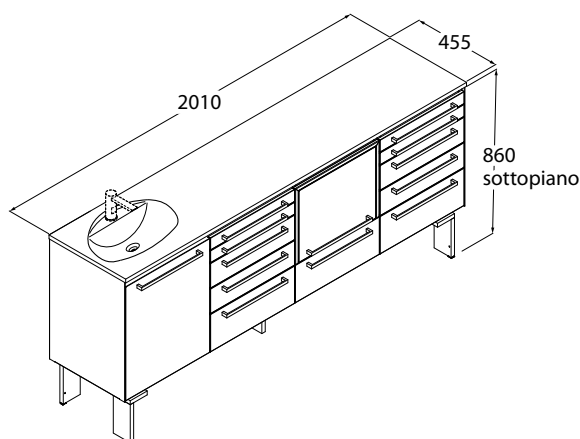

- | | | |
|----------|---|--------------|
| 1 | Piano in laminato Fenix® "Fenix®" - laminate worktop / Plan de travail en laminé "Fenix®" / Arbeitsplatte aus Laminat "Fenix®" / Encimera de laminado "Fenix®" | + VCF |
| 2 | Piano in stratificato Stratified top / Plan stratifié / Arbeitsplatte aus Schichtstoff / Encimera de estratificado | + VCS |
| 3 | Piano in vetro Glass top / Plan en verre Arbeitsplatte aus Glas / Encimera de vidrio | + VIV |
| 4 | Piano in Corian® Corian® top / Plan en Corian® Arbeitsplatte aus Corian® / Encimera de Corian® | + VTC |

D **Composizione** / Composition
Composition / Zusammenstellung / Composición

LLA + L5A + LRA + L5A

La composizione è comprensiva di bacinelle standard. Rubinetto escluso.

Trays included. Mixer excluded

Intérieurs de tiroirs inclus. Robinet pas compris.

Standard Schubladeneinsätze sind enthalten. Armatur ist ausgeschlossen.

La composición incluye bandejas estándar. Grifo excluido.

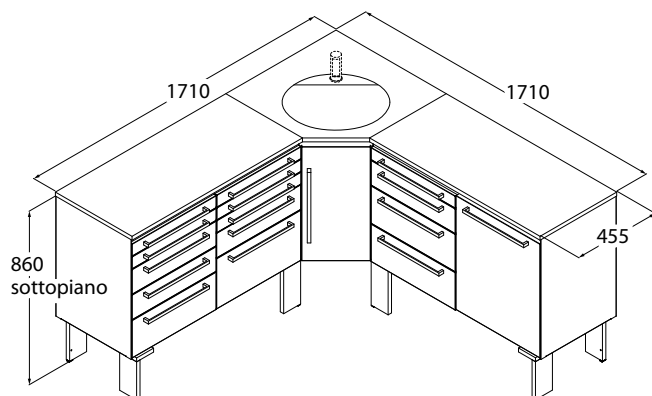

- | | | |
|---|---|-------|
| 1 | Piano in laminato Fenix® "Fenix®" - laminate worktop / Plan de travail en laminé "Fenix®" / Arbeitsplatte aus Laminat "Fenix®" / Encimera de laminado "Fenix®" | + VCF |
| 2 | Piano in stratificato Stratified top / Plan stratifié / Arbeitsplatte aus Schichtstoff / Encimera de estratificado | + VCS |
| 3 | Piano in vetro Glass top / Plan en verre Arbeitsplatte aus Glas / Encimera de vidrio | + VIV |
| 4 | Piano in Corian® Corian® top / Plan en Corian® Arbeitsplatte aus Corian® / Encimera de Corian® | + VTC |

E **Composizione / Composition**
Composition / Zusammenstellung / Composición

L5A + L5B + LAA + L4C + LPA

La composizione è comprensiva di bacinelle standard. Rubinetto escluso.

Trays included. Mixer excluded

Intérieurs de tiroirs inclus. Robinet pas compris.

Standard Schubladeneinsätze sind enthalten. Armatur ist ausgeschlossen.

La composición incluye bandejas estándar. Grifo excluido.

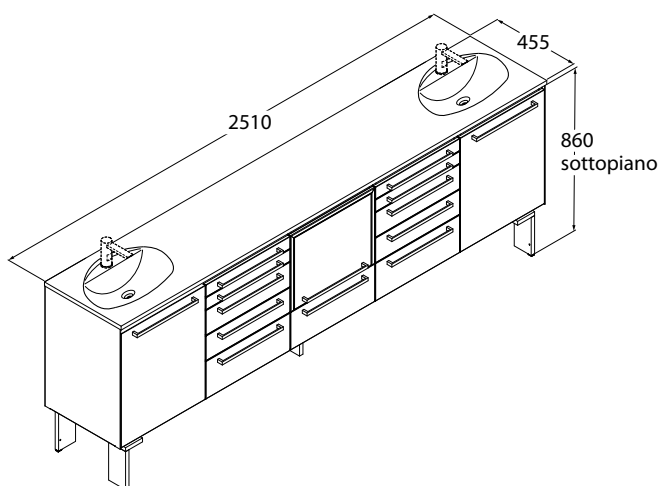

- | | | |
|---|---|-------|
| 1 | Piano in laminato Fenix® "Fenix®" - laminate worktop / Plan de travail en laminé "Fenix®" / Arbeitsplatte aus Laminat "Fenix®" / Encimera de laminado "Fenix®" | + VCF |
| 2 | Piano in stratificato Stratified top / Plan stratifié / Arbeitsplatte aus Schichtstoff / Encimera de estratificado | + VCS |
| 3 | Piano in vetro Glass top / Plan en verre Arbeitsplatte aus Glas / Encimera de vidrio | + VIV |
| 4 | Piano in Corian® Corian® top / Plan en Corian® Arbeitsplatte aus Corian® / Encimera de Corian® | + VTC |

F **Composizione / Composition**
Composition / Zusammenstellung / Composición

LLA + L5A + LRAM + L5A + LLA

La composizione è comprensiva di bacinelle standard. Rubinetto escluso.

Trays included. Mixer excluded

Intérieurs de tiroirs inclus. Robinet pas compris.

Standard Schubladeneinsätze sind enthalten. Armatur ist ausgeschlossen.

La composición incluye bandejas estándar. Grifo excluido.

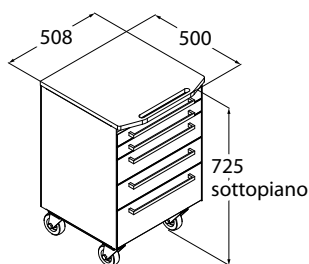

1 Piano in stratificato
Stratified top / Plan stratifié / Arbeitsplatte aus Schichtstoff /
Encimera de estratificado

2 Piano in vetro
Glass top / Plan en verre
Arbeitsplatte aus Glas / Encimera de vidrio

3 Piano in Corian®
Corian® top / Plan en Corian®
Arbeitsplatte aus Corian® / Encimera de Corian®

G Servomobile / Composition
Composition / Zusammenstellung / Composición

L5A + KR

Il servomobile è comprensivo di bacinelle standard.

Trays included.

Intérieurs de tiroirs inclus.

Standard Schubladeneinsätze sind enthalten.

La composición incluye bandejas estándar.

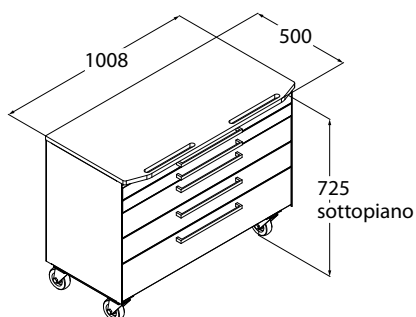

1 Piano in stratificato
Stratified top / Plan stratifié / Arbeitsplatte aus Schichtstoff /
Encimera de estratificado

2 Piano in vetro
Glass top / Plan en verre
Arbeitsplatte aus Glas / Encimera de vidrio

3 Piano in Corian®
Corian® top / Plan en Corian®
Arbeitsplatte aus Corian® / Encimera de Corian®

H Servomobile / Composition
Composition / Zusammenstellung / Composición

L5A_2 + KR

Il servomobile è comprensivo di bacinelle standard.

Trays included.

Intérieurs de tiroirs inclus.

Standard Schubladeneinsätze sind enthalten.

La composición incluye bandejas estándar.

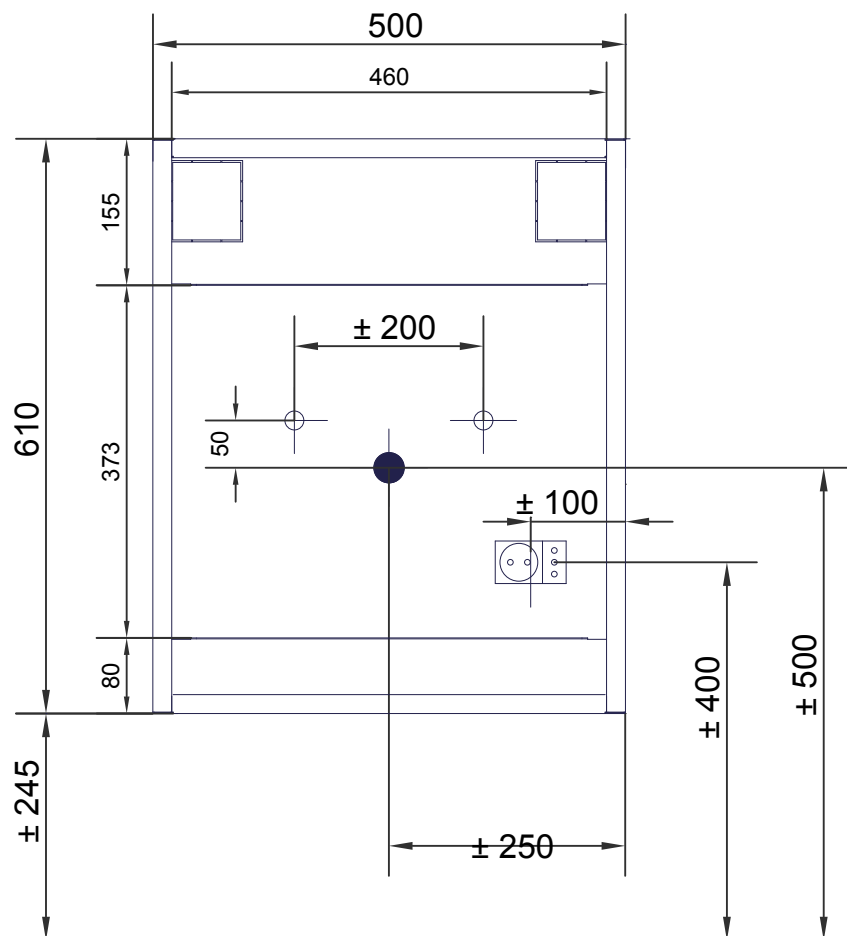

Il presente listino sostituisce e annulla tutti i precedenti e può essere modificato in qualsiasi momento senza preavviso. I prezzi si intendono al netto di iva. **L'imballo non è compreso nel prezzo.** L'installazione è a carico del cliente.

L'ordine, e ogni modifica ad esso, dovrà essere inoltrato per iscritto e sarà da considerarsi accettato solo dopo l'invio di una conferma da parte di Loran srl. I termini fissati per la spedizione non sono tassativi e in nessun caso potranno costituire pretesto per ritardi di pagamento o richiesta di risarcimento.

La merce viaggia a rischio e pericolo del committente, franco stabilimento Loran srl a Pieve di Soligo. Se non indicato per iscritto, la merce sarà spedita col mezzo ritenuto più opportuno da Loran srl. **Eventuali reclami di trasporto devono essere fatti al momento della consegna direttamente al vettore.**

Eventuali difetti di fabbricazione devono essere comunicati a mezzo raccomandata alla sede Loran srl di Pieve di Soligo entro 8 giorni dalla data di ricevimento merce, anche se segnalati prima in altra forma. In ogni caso non danno diritto al cliente di sospendere i pagamenti.

Nessun materiale dovrà essere reso senza nostra autorizzazione scritta. I resi autorizzati ci dovranno pervenire in porto franco accompagnati da documento di trasporto che indichi il numero e la data della fattura relativa alla fornitura originaria e saranno gravati del 15% per spese generali.

Il materiale di produzione Loran srl ha garanzia di anni due, salvo eventuali danni o manomissioni causati dall'utilizzatore.

La merce venduta rimane di proprietà della venditrice fino al pagamento totale da parte dell'acquirente. In caso contrario la venditrice si riserva la facoltà di ritirarla in qualsiasi momento. Ogni controversia sarà competenza del foro di Treviso (Italia).

This price list can be modified at any time, without notice. The prices do not include vat. **Packing is not included in the price.** Installation shall be charged to the customer.

Order as well as any modifications of such orders shall be made in writing and shall be considered accepted upon our written confirmation. Delivery terms are not binding and under no circumstance may they be used as a pretext to justify delays in payment or claims for compensation.

The goods travel at the purchaser's risk on a ex-works basis from our factory in Pieve di Soligo (Italy): unless otherwise specified in writing, the goods will be shipped with the means of transport considered most suitable by our company. The goods shall be checked by the receiver as soon as they reach their destination and **any claim for damages shall be filed directly with the carrier.**

Any manufacturing fault shall be immediately communicated by registered letter to our offices in Pieve di Soligo within 8 days after the goods have been received, and may also be communicated in other additional ways. By no means shall manufacturing defects entitle the purchaser to stop payments.

No goods shall be returned without our written authorization. Authorized returned goods shall be sent to us free port, together with a "returned goods" note showing the number and date of our original invoice related to such. 15% of total value shall be charged to our customer.

All Loran products are guaranteed for two years. The warranty shall no longer be valid if the product has been damaged or tampered with by the user.

Goods sold remain property of the seller until fully paid by the buyer. Should this not be the case, the seller shall be entitled to withdraw its goods at any time. In the event of any and all disputes, competent court shall exclusively be the court of Treviso (Italy).

Cette liste de prix est susceptible d'être modifiée à n'importe quel moment sans préavis. Les prix sont exprimés HT.
Les prix ne comprennent pas l'emballage.
L'installation est à la charge du client.

La commande, et toute modification éventuelle à celle-ci, devra être transmise par écrit et ne pourra être considérée acceptée qu'après l'envoi d'une confirmation écrite de notre part. Les délais fixés pour l'expédition ne constituent pas un terme de rigueur et ne pourront en aucun cas constituer prétexte pour retarder les paiements ou pour exiger un remboursement ou des dommages.

La marchandise voyage aux risques et périls du client, franco départ-usine Loran srl de Pieve di Soligo (Italie):
en absence d'instructions écrites précises de la part du client, la marchandise sera envoyée par le moyen que nous jugerons le plus indiqué. **Les éventuelles réclamations concernant le transport devront être faites directement au transporteur au moment même de la livraison.**

Les éventuels défauts de fabrication devront être signalés, par lettre recommandée dans les 8 jours à compter de la date de réception de la marchandise, à Loran srl de Pieve di Soligo; et cela, même si déjà signalés au travers un autre moyen ou forme. De toute façon, il est entendu qu'une éventuelle réclamation ne donne en aucun cas le droit au client d'interrompre les paiements.

Aucun matériel ne pourra être rendu sans notre autorisation écrite. Les retours autorisés de marchandise devront nous parvenir franco de port et munis d'un bulletin de transport officiel indiquant entre autre le numéro et la date de la facture relative à la commande d'origine. Il est entendu que les marchandises rendues seront grevées de 15% pour cause de frais généraux.

Le matériel de Loran srl production bénéficie d'une garantie 2 ans, sujette à déchéance en cas de dégâts provoqués par l'utilisateur ou, de quelque manière, imputables à celui-ci.

Il est entendu que jusqu'au paiement complet par de l'acheteur de la marchandise vendue, celle-ci reste la propriété de l'entreprise vendeuse qui aura donc la faculté de retirer la marchandise à n'importe quel moment en cas de défaut, même partiel, de paiement. Il est entendu que tout différent ou litige entre les parties sera du ressort du tribunal de Treviso (Italie).

Diese Preisliste kann jederzeit und ohne Vorankündigung geändert werden. Die Preise verstehen sich zuzüglich Mehrwertsteuer. **Die Preise verstehen sich ausschließlich Verpackung.** Die Installation erfolgt auf Kosten des Kunden.

Der Auftrag und jede diesbezügliche Änderung hat schriftlich zu erfolgen und gilt erst nach unserer Auftragsbestätigung als angenommen. Die Lieferdaten sind nicht bindend und berechtigen keinesfalls zu Zahlungsverzögerungen oder Schadenersatzforderungen.

Die Ware reist auf alleinige Gefahr des Auftraggebers ab unserem Firmensitz in Pieve di Soligo (Italien): falls nicht anders schriftlich vereinbart, wird die Ware mit dem von uns als geeignet erachteten Transportmittel befördert. **Eventuelle Beanstandungen bezüglich des Transports sind bei der Anlieferung direkt dem Frachtführer zu melden.**

Fabrikationsfehler sind unserem Firmensitz in Pieve di Soligo innerhalb von 8 Tagen nach Erhalt der Ware per Einschreiben zu melden, auch wenn Sie vorher bereits in anderer Form mitgeteilt wurden. In jedem Fall berechtigen Sie den Kunden nicht zur Einstellung der Zahlungen.

Materialrückstellungen dürfen nur mit unserer schriftlichen Genehmigung erfolgen. Die genehmigten Rückstellungen haben Frachtfrei mit einem Transportschein zu erfolgen, auf dem die Rechnungsnummer und das Rechnungsdatum bezüglich der ursprünglichen Lieferung vermerkt sind, wobei 15% für allgemeine Kosten berechnet werden.

Das Material von Loran srl hat eine zweijährige Garantie, außer bei Schäden oder unsachgemäßer Behandlung durch den Anwender.

Die verkaufte Ware bleibt Eigentum des Verkäufers bis zur vollständigen Zahlung seitens des Käufers. Andernfalls behält sich der Verkäufer das Recht vor, die Ware jederzeit abzuholen. Für jegliche Streitigkeiten ist das Gericht von Treviso (Italien) zuständig.

La presente lista de precios puede ser modificada en cualquier momento y sin previo aviso. Los precios se consideran sin IVA. **El embalaje no está incluido en el precio.** La instalación está a cargo del cliente.

El pedido, y toda modificación del mismo, se deberá enviar por escrito y se considerará aceptado sólo después del envío de una confirmación por parte de Loran srl. Los plazos fijados para la expedición no son taxativos y en ningún caso podrán constituirse en un pretexto para retrasar el pago o pedir resarcimiento.

La mercancía viaja por cuenta y riesgo del cliente, desde Loran srl en Pieve di Soligo (Italia).
Si no estuviera especificado por escrito, la mercancía será enviada por el medio de transporte considerado más conveniente por Loran srl. **Eventuales reclamos por el transporte se deberán realizar en el momento de la entrega directamente al transportista.**

Los defectos de fabricación deberán comunicarse mediante carta certificada a la sede de Loran srl de Pieve di Soligo, dentro de los 8 días a partir de la fecha de recepción de la mercancía, incluso si se comunicaron antes por otro medio. En cualquier caso esto no otorga derecho al cliente para suspender los pagos.

Ningún material podrá entregarse sin nuestra autorización escrita. Las entregas autorizadas deberán realizarse en puerto franco acompañadas por el documento de transporte que indique el número y la fecha de la factura correspondiente al suministro original y estarán gravados con 15% para gastos generales.

El material producido por Loran srl tiene una garantía de dos años, excepto eventuales daños o alteraciones causados por el usuario.

La mercancía vendida continuará perteneciendo al vendedor hasta el pago total por parte del comprador. En caso contrario el vendedor se reserva la facultad de retirarla en cualquier momento. Toda controversia será competencia de los tribunales de Treviso (Italia).

Loran
everyday passion



LORAN srl • Via della Lira, 397 zona ind. • 31053 Pieve di Soligo • TV • Italy
Tel. +39 0438 842603 • Fax +39 0438 980233 • loran@loran.it • www.loran.it